

HAZ METAL
FIXING SYSTEMS

HA04

HA L ANCHOR FIXING SYSTEM

Concept Drawings

Series: HAZCD-HA04-ST

Direct Fixing System For Rain Screen
Stone Cladding System for Installation at
Vertical and Horizontal Joints

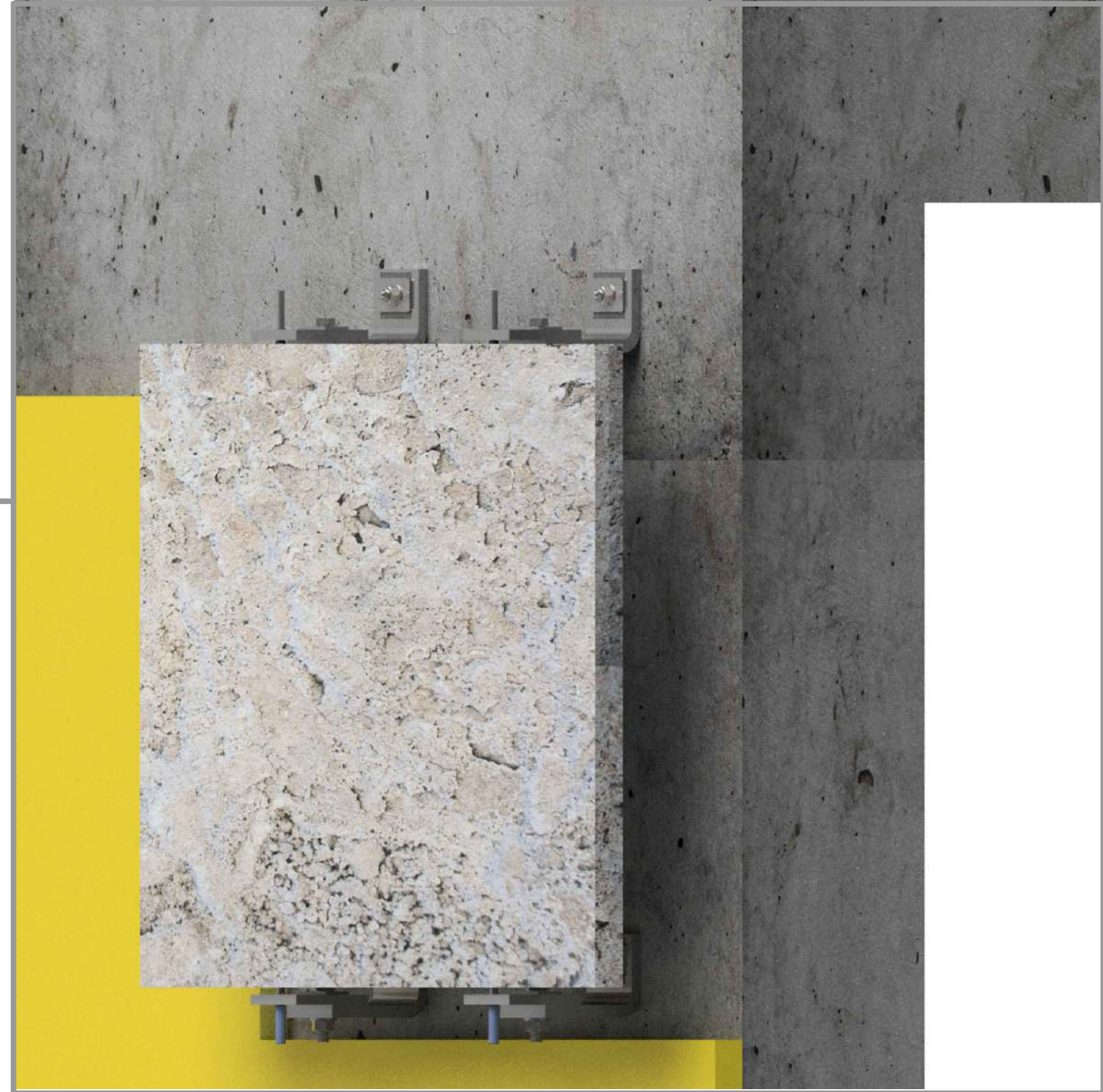

HA04

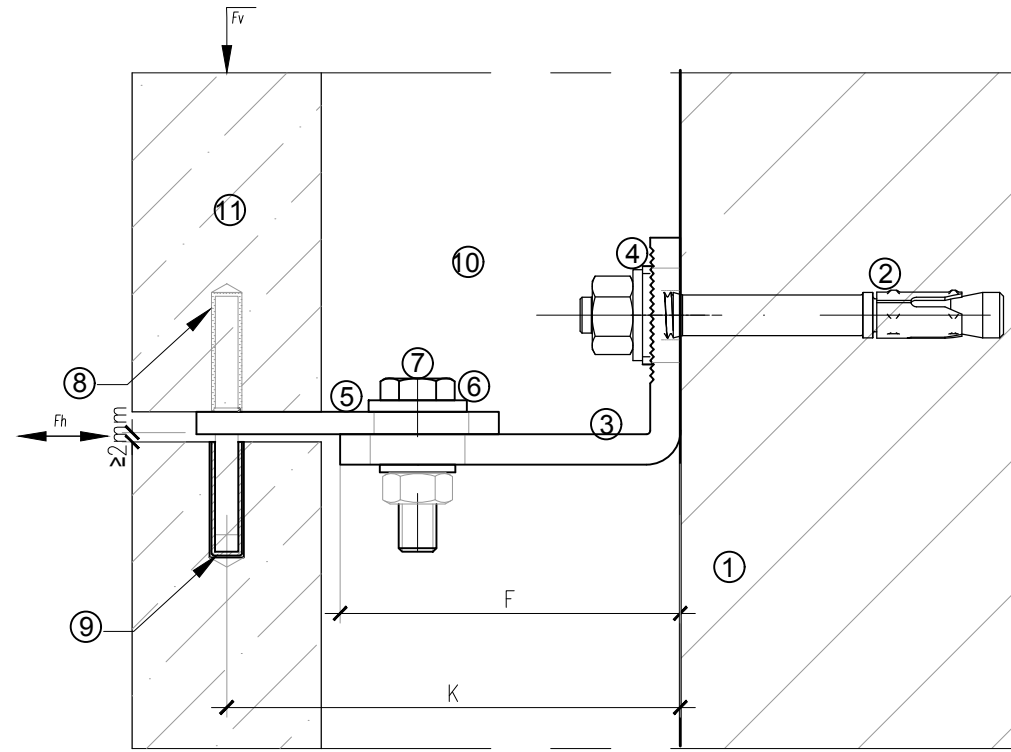
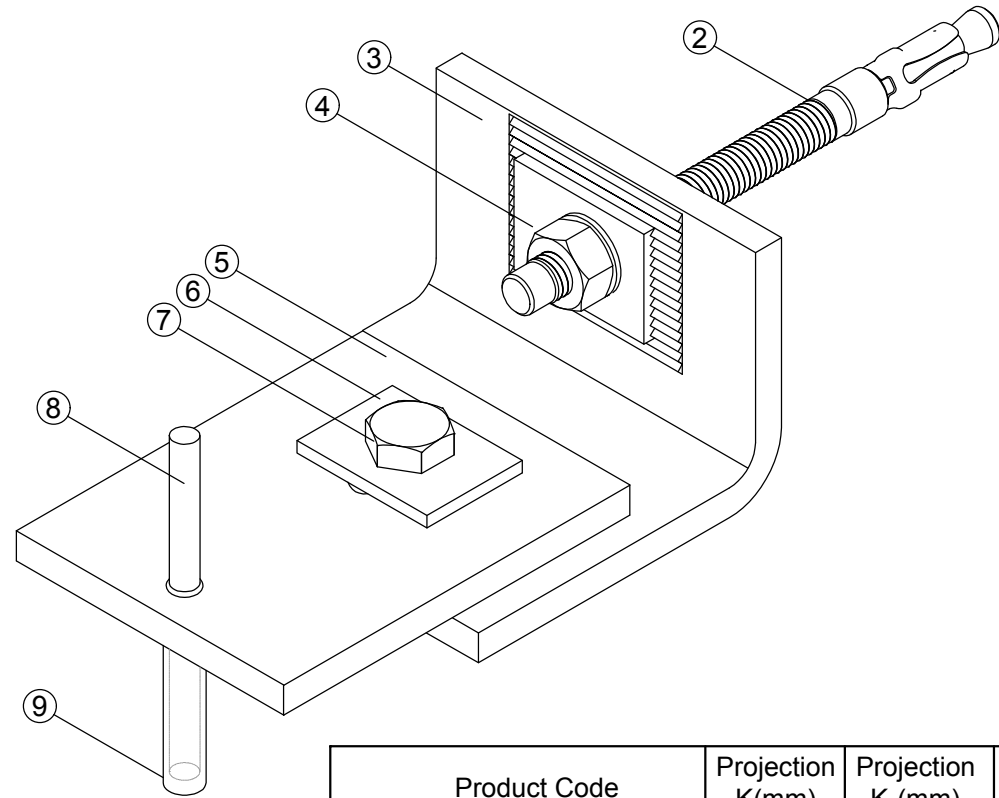

Scale 1:2

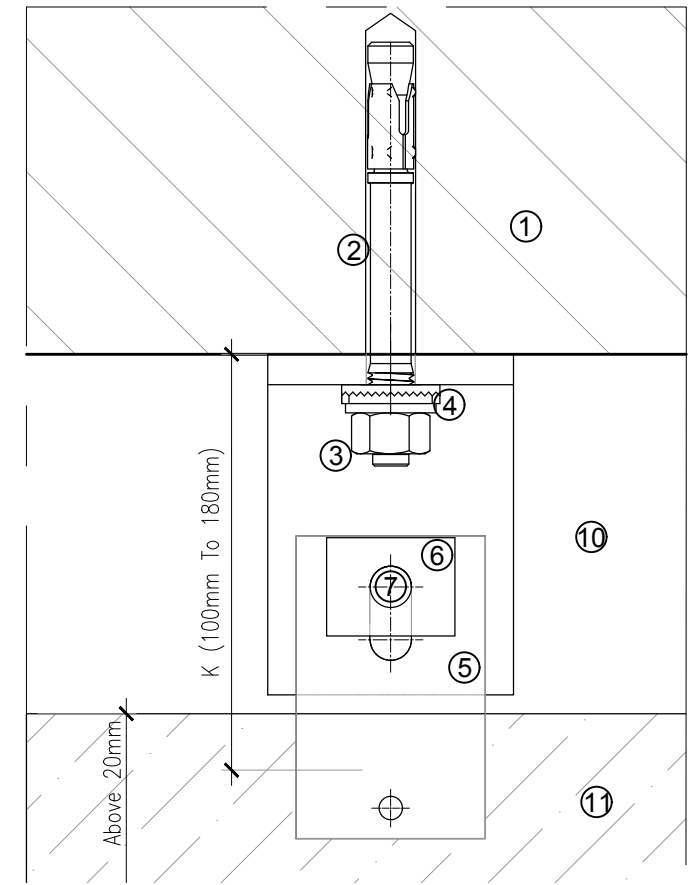

Scale 1:2

Product Code	Projection K(mm)	Projection K-(mm)	Projection K+(mm)	Dead. Load Fdw(N)	Wind Pressure Fwp(N)	Forming Size F(mm)	Expansion Bolt Size (mm)	Adjustable Plate Length (mm)	Adjustable Plate Thickness (mm)
HA04-1006	100	85	115	600	936	70	M12x120	80	6
HA04-1206	120	105	135						
HA04-1406	140	125	155						
HA04-1606	160	145	175						
HA04-1806	180	165	195						
HA04-1008	100	85	115	800	1235	70			
HA04-1208	120	105	135						
HA04-1408	140	125	155						
HA04-1608	160	145	175						
HA04-1808	180	165	195						

Legend	
1	Substrate
2	Anchor Bolt
3	HA04-1206 Anchor Body
4	Serrated Washer
5	Adjustable Plate
6	Plain Washer
7	Bolt Set
8	FLANGED PIN
9	PLASTIC TUBE
10	Cavity
11	Stone panel



HAZ METAL Sanayi ve Ticaret A.S
 PO Box 241 31200 Iskenderun / Turkey
 Tel: +90 326 6262050 Faks: 6262045
 info@hazmetal.com / www.hazmetal.com.

Title : Natural Stone Facade - Built-up Cavity Wall - System HA04 Specification

Drawing No. HAZCD-HA04 - ST-001

Series Concept Drawings - Natural Stone Fixing System - HA04 Support Anchors

Revision 01 scale As Shown

Page : 01/11

HA04

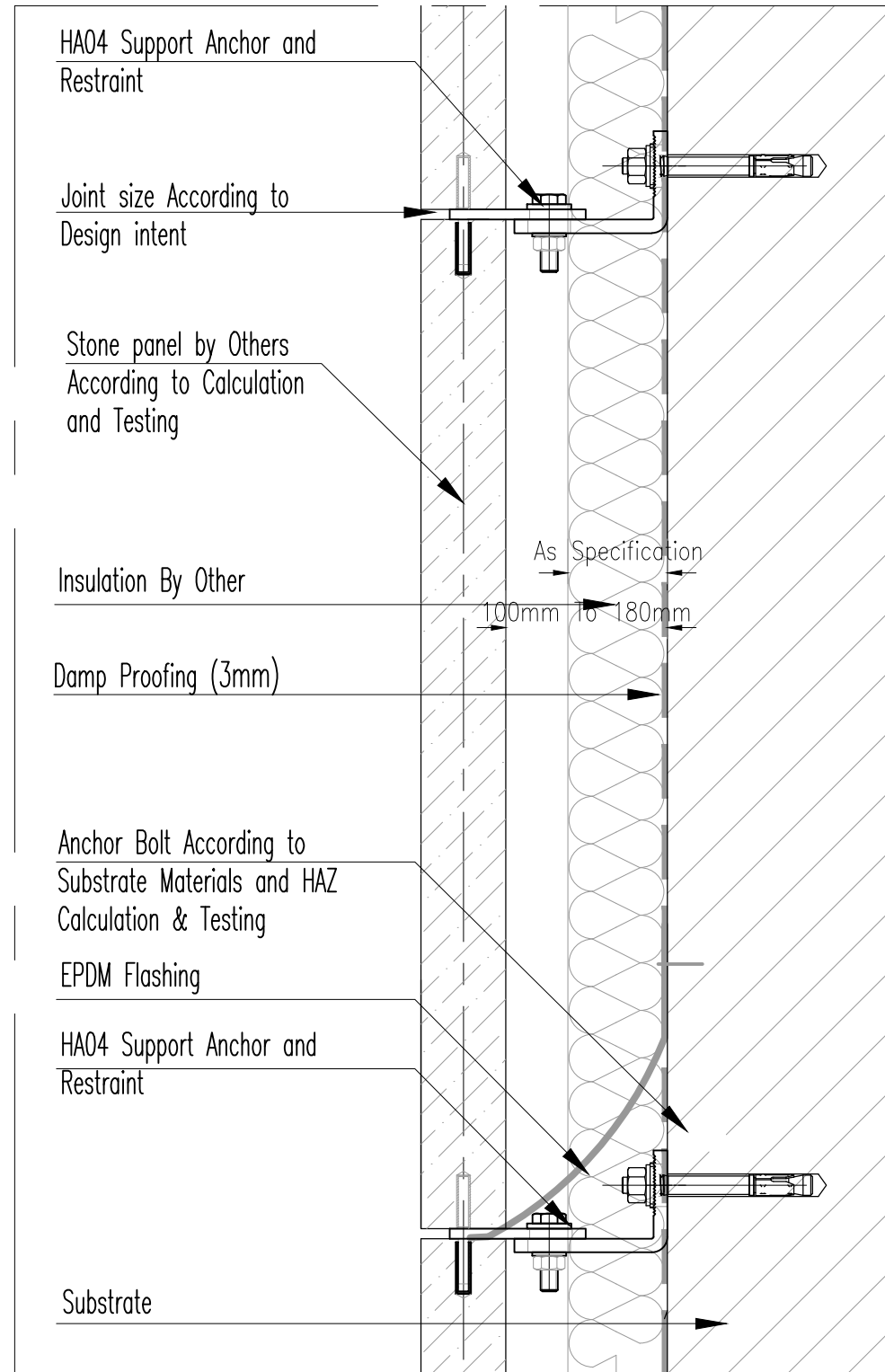

Vertical section Scale 1:4

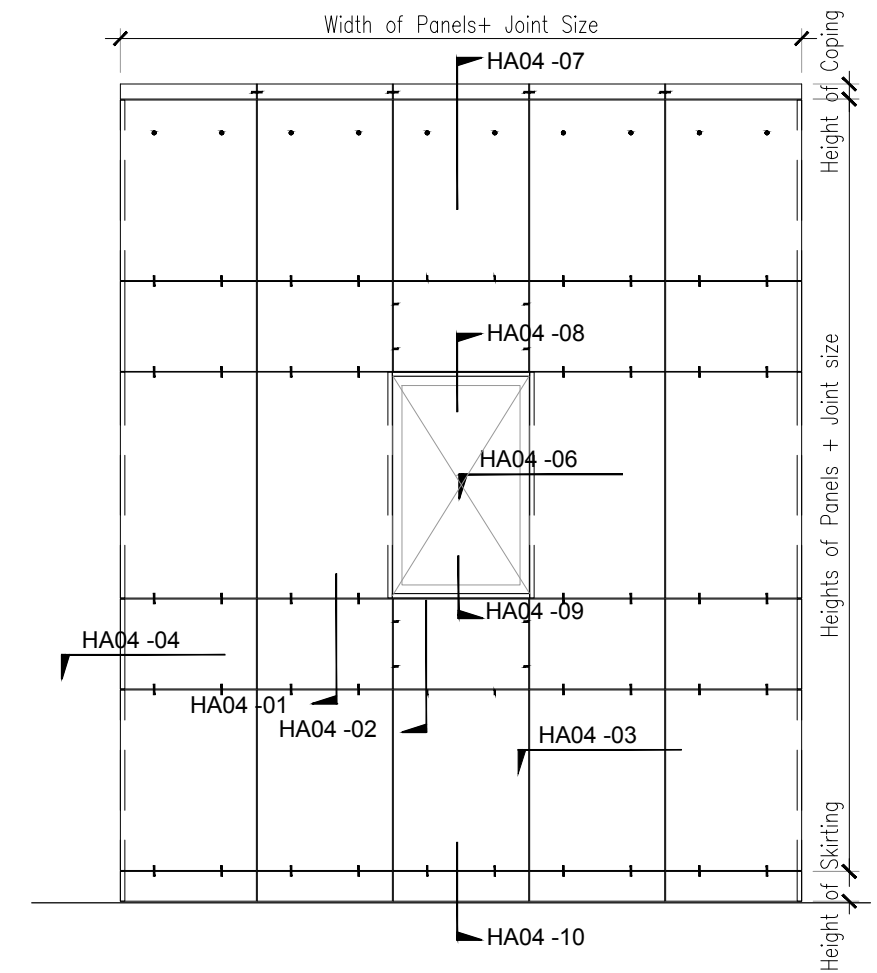

Elevation Scale 1:50



HAZ METAL Sanayi ve Ticaret A.S
 PO Box 241 31200 Iskenderun / Turkey
 Tel: +90 326 6262050 Faks: 6262045
 info@hazmetal.com / www.hazmetal.com.

Title :		Horizontal Joint Installation - Typical Stone Claddings / Rain Screen - Vertical Section		
Drawing No.	HAZCD-HA04 - ST-002			
Series	Concept Drawings - Natural Stone Fixing System - HA04 Support Anchors			
Revision	01	scale	As Shown	Page : 02/11

HA04

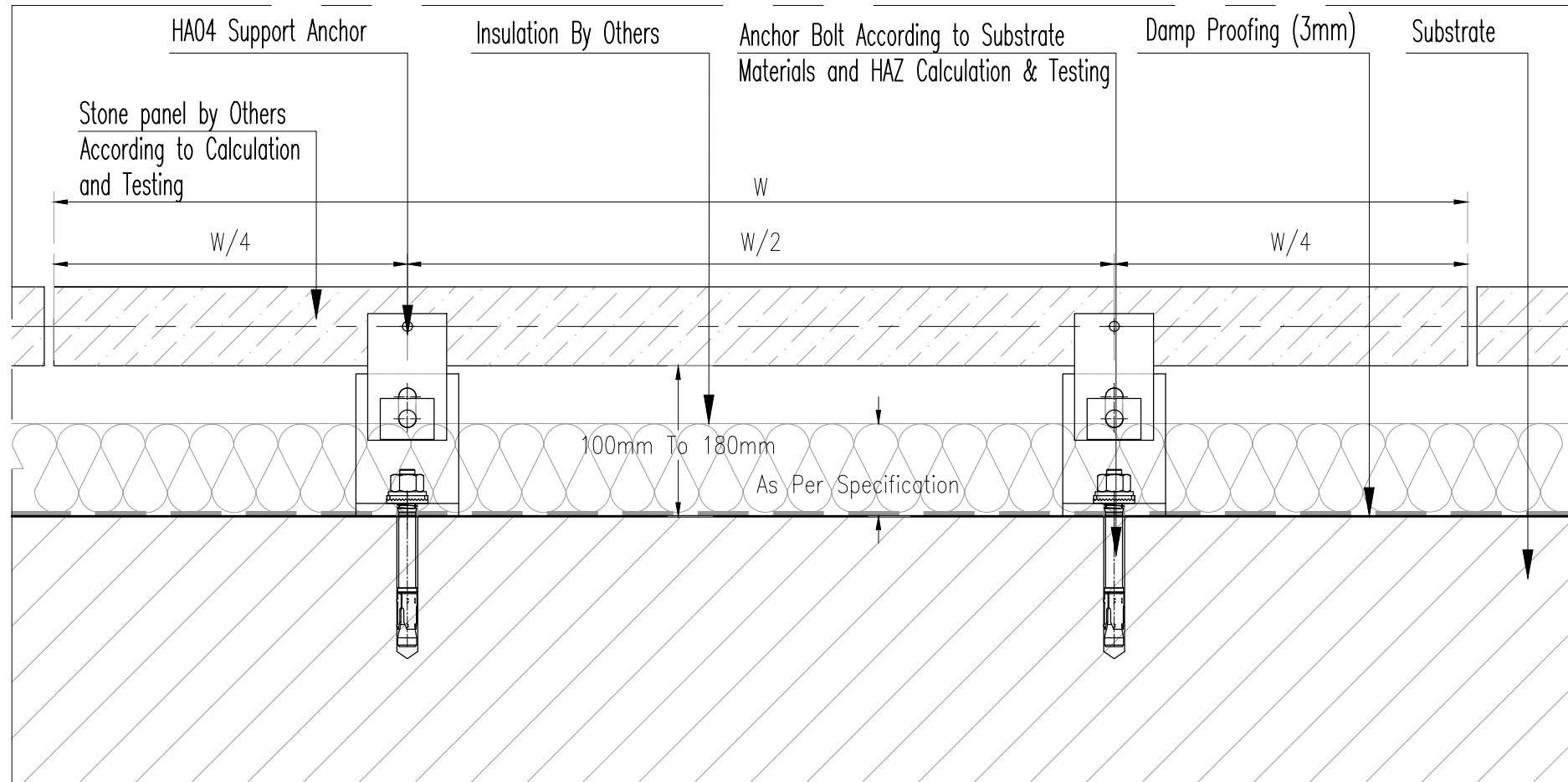

Horizontal section Scale 1:4

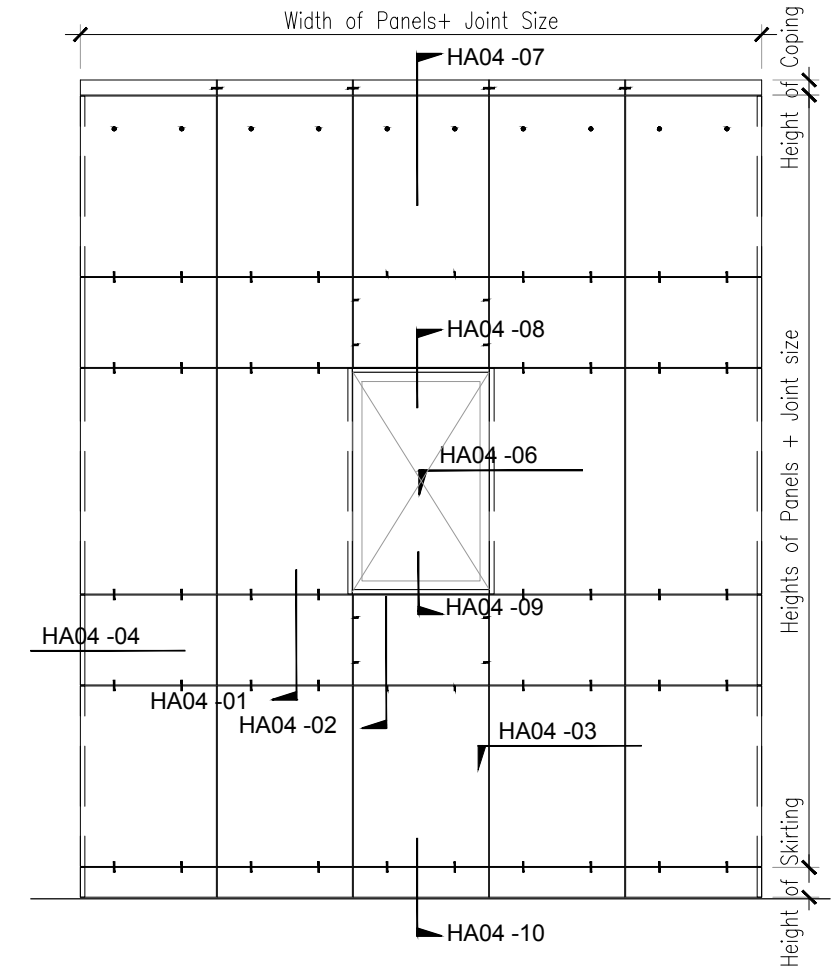

Elevation Scale 1:50



HAZ METAL Sanayi ve Ticaret A.S
 PO Box 241 31200 Iskenderun / Turkey
 Tel: +90 326 6262050 Faks: 6262045
 info@hazmetal.com / www.hazmetal.com.

Title :		Horizontal Joint Installation - Typical Stone Claddings / Rain Screen - Horizontal Section		
Drawing No.	HAZCD-HA04 - ST-004			
Series	Concept Drawings - Natural Stone Fixing System - HA04 Support Anchors			
Revision	01	scale	As Shown	Page : 03/11

HA04

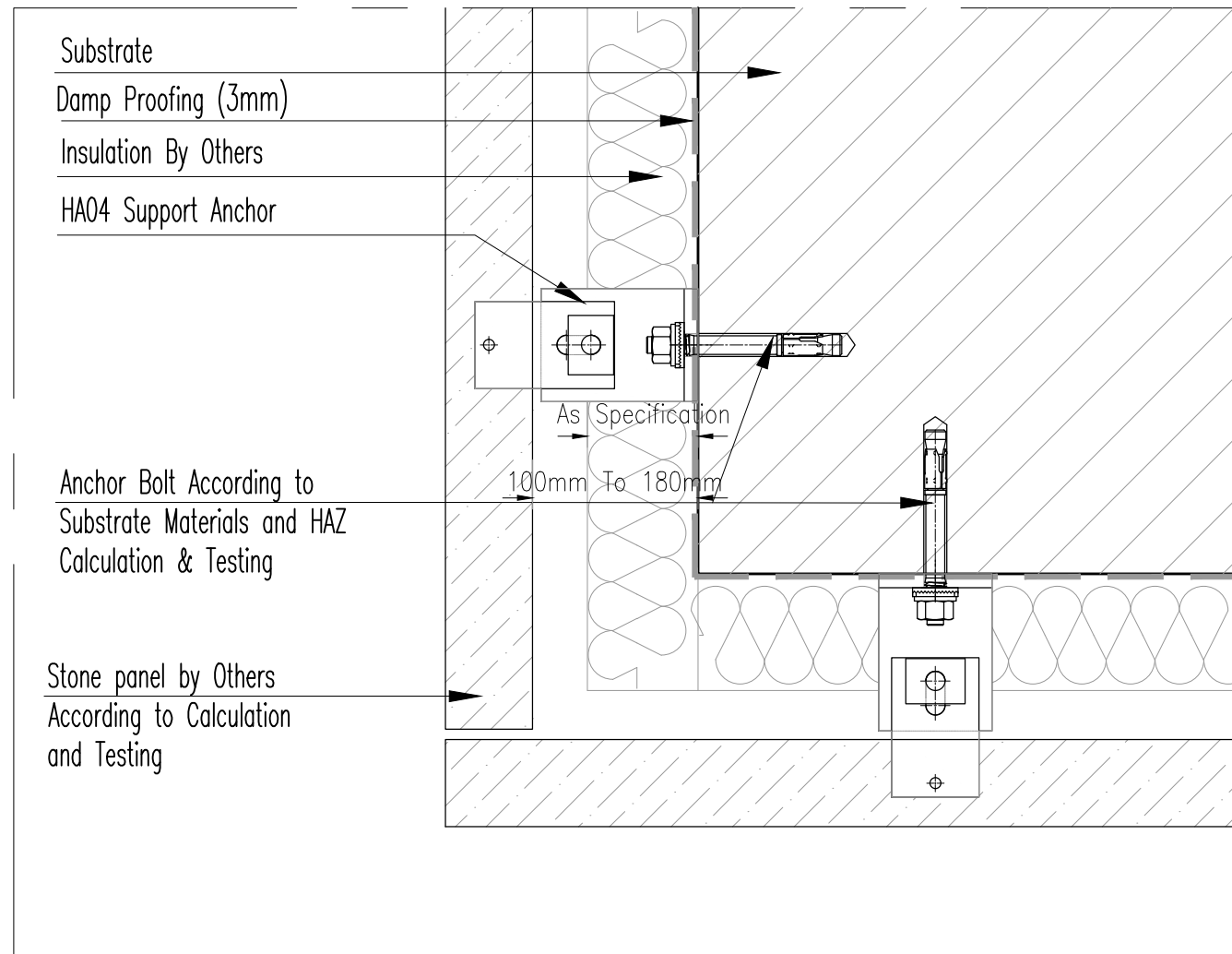

Horizontal section Scale 1:4

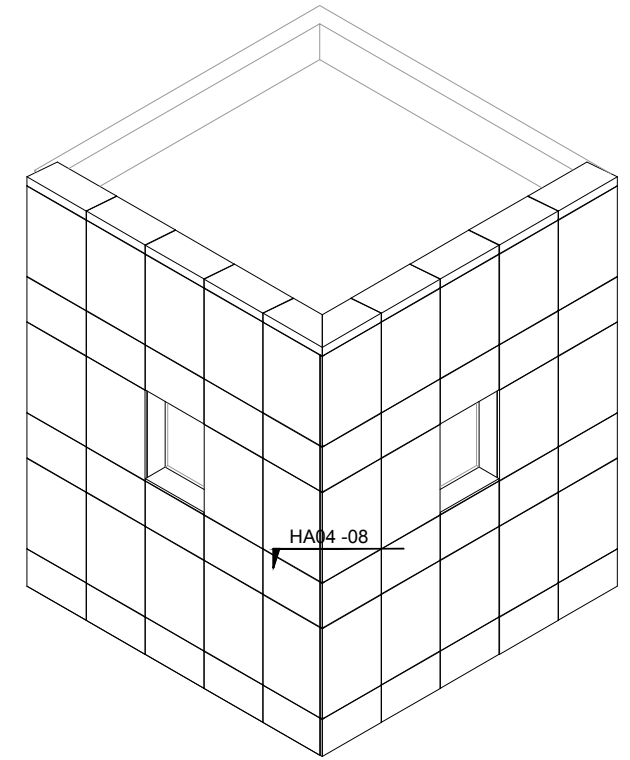

Isometric Scale 1:100



HAZ METAL Sanayi ve Ticaret A.S
 PO Box 241 31200 Iskenderun / Turkey
 Tel: +90 326 6262050 Faks: 6262045
 info@hazmetal.com / www.hazmetal.com.

Title :		Horizontal Joint Installation - External Corner Stone Cladding - Horizontal Section		
Drawing No.	HAZCD-HA04 - ST-005			
Series	Concept Drawings - Natural Stone Fixing System - HA04 Support Anchors			
Revision	01	scale	As Shown	Page : 04/11

HA04

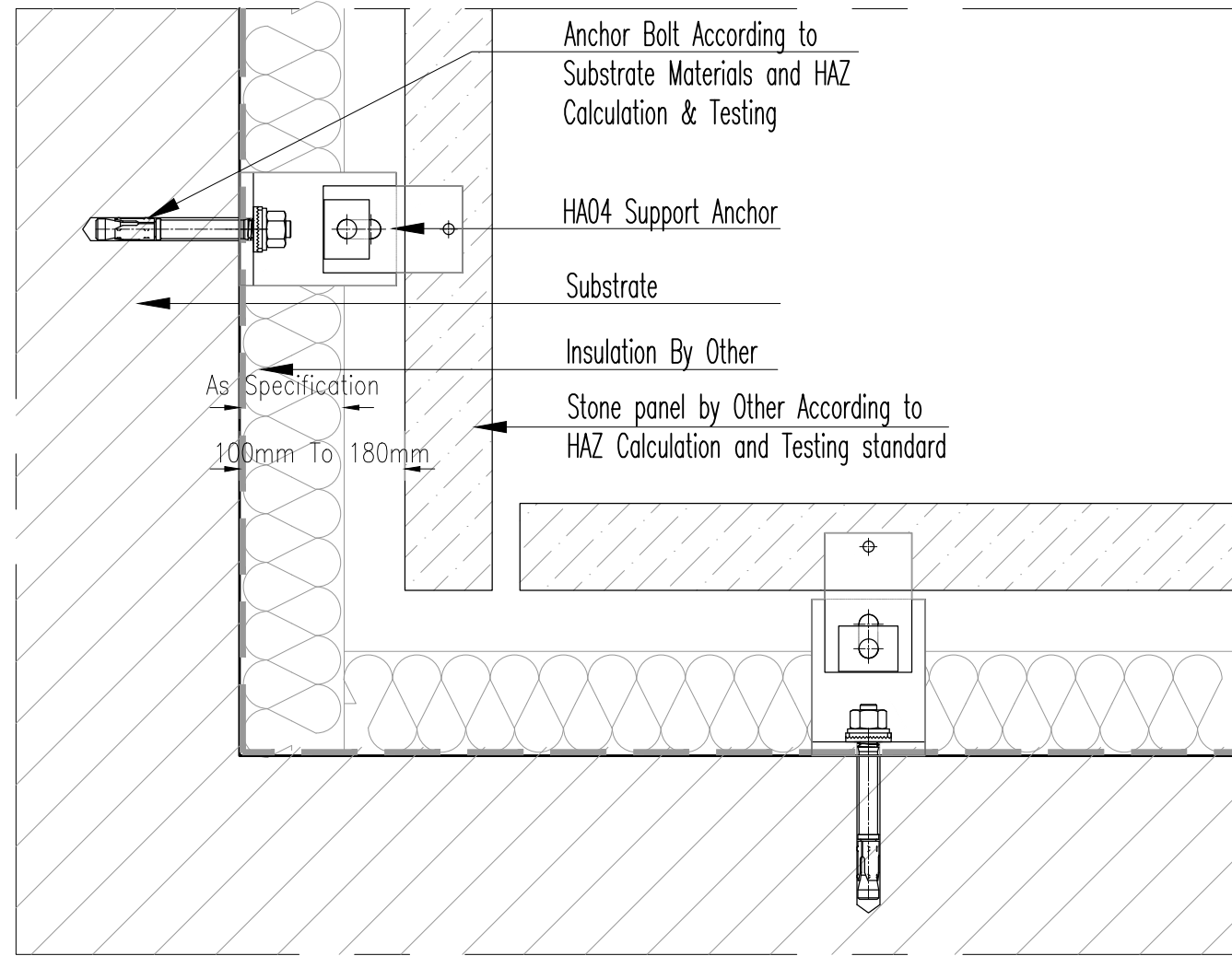

Horizontal section Scale 1:4

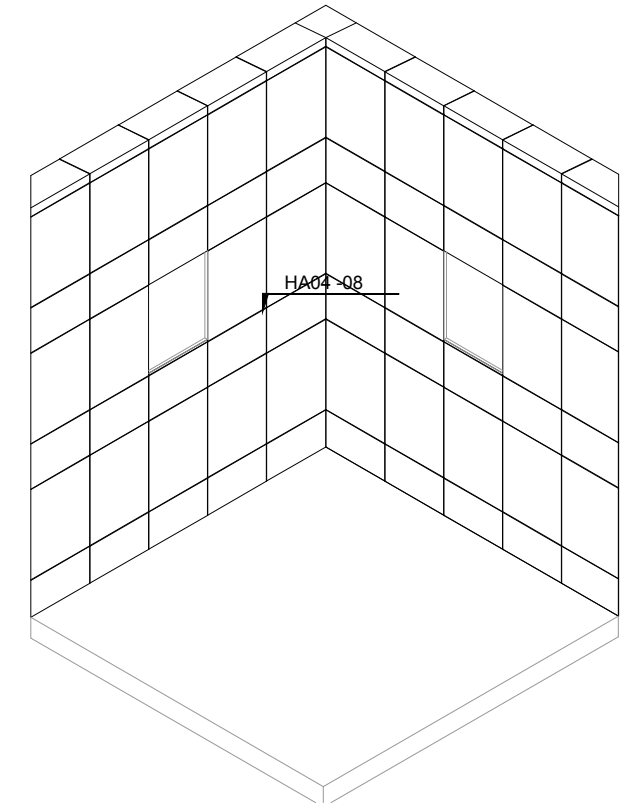

Isometric Scale 1:100



HAZ METAL Sanayi ve Ticaret A.S
 PO Box 241 31200 Iskenderun / Turkey
 Tel: +90 326 6262050 Faks: 6262045
 info@hazmetal.com / www.hazmetal.com.

Title :		Horizontal Joint Installation - Internal Corner Stone Cladding - Horizontal Section		
Drawing No.	HAZCD-HA04 - ST-006			
Series	Concept Drawings - Natural Stone Fixing System - HA04 Support Anchors			
Revision	01	scale	As Shown	Page : 05/11

HA04

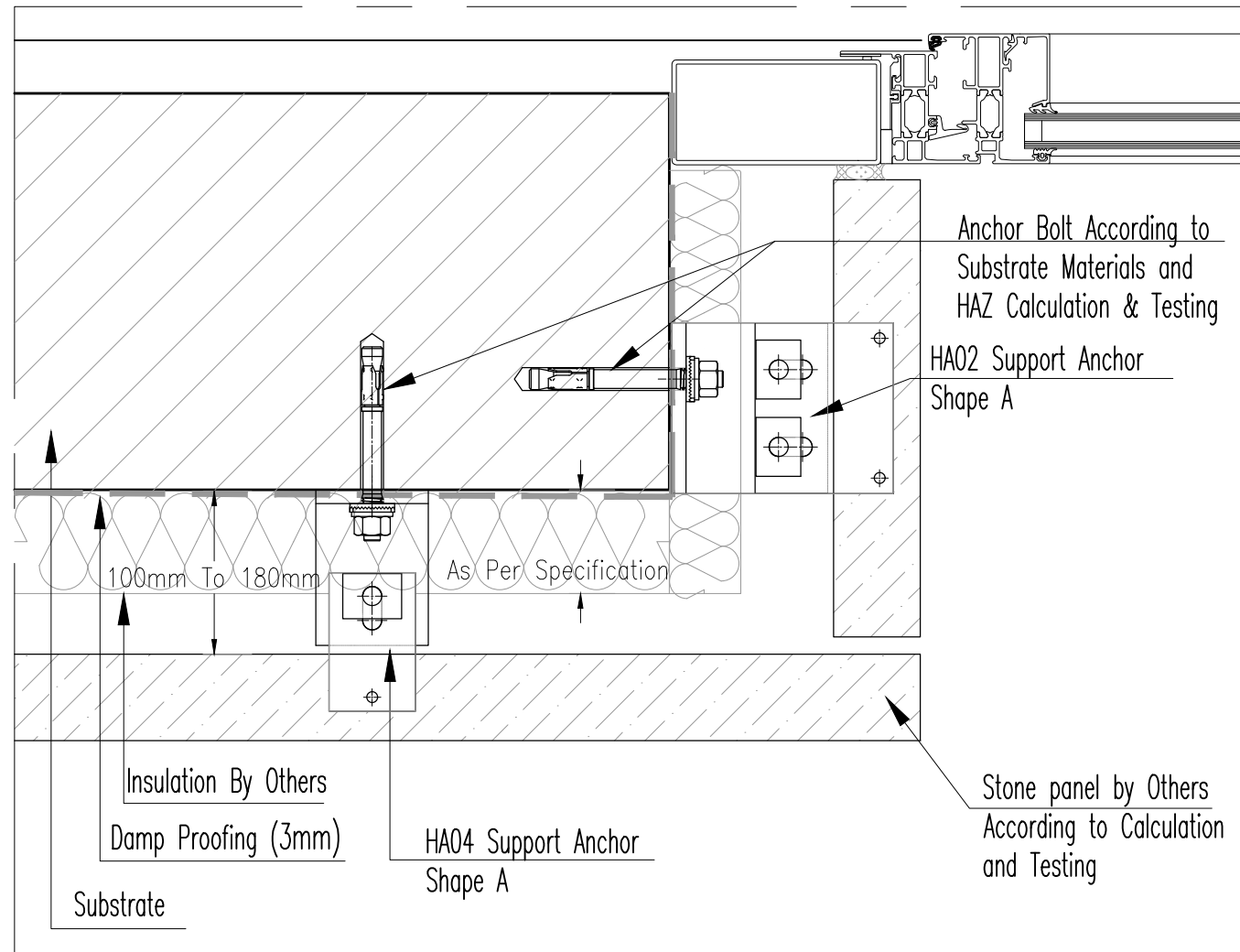

Horizontal section Scale 1:4

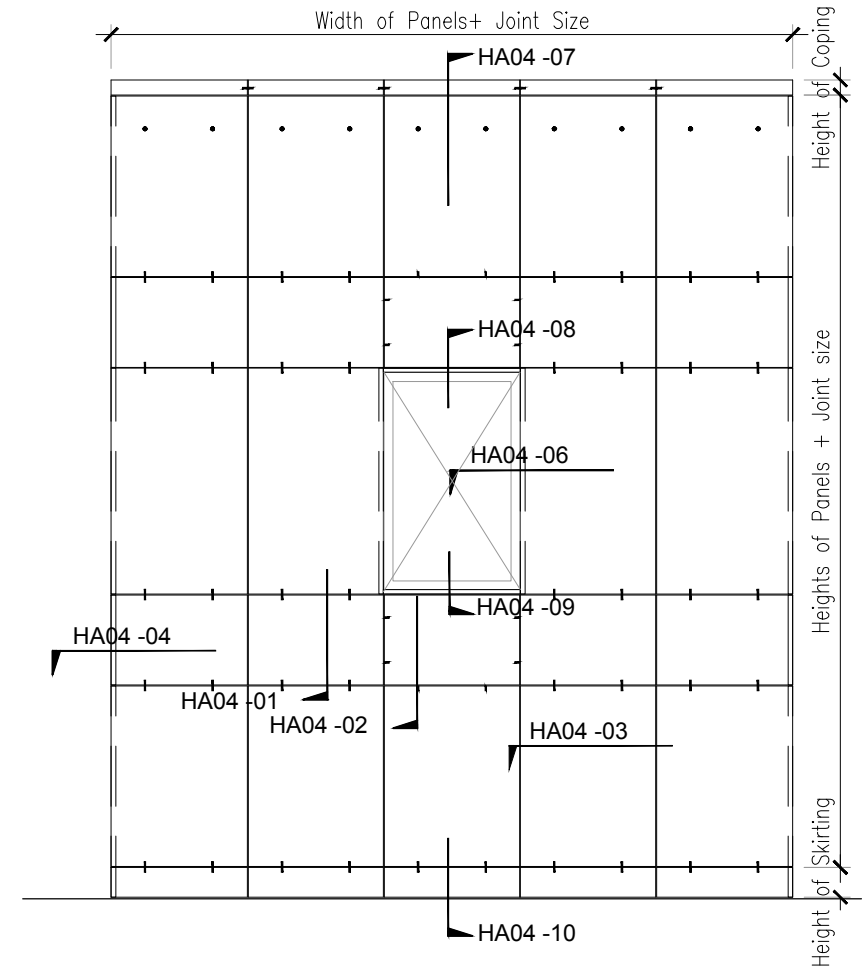

Elevation Scale 1:50



HAZ METAL Sanayi ve Ticaret A.S
 PO Box 241 31200 Iskenderun / Turkey
 Tel: +90 326 6262050 Faks: 6262045
 info@hazmetal.com / www.hazmetal.com.

Title :		Horizontal Joint Installation - Stone Reveal - Horizontal Section		
Drawing No.	HAZCD-HA04 - ST-007			
Series	Concept Drawings - Natural Stone Fixing System - HA04 Support Anchors			
Revision	01	scale	As Shown	Page : 06/11

HA04

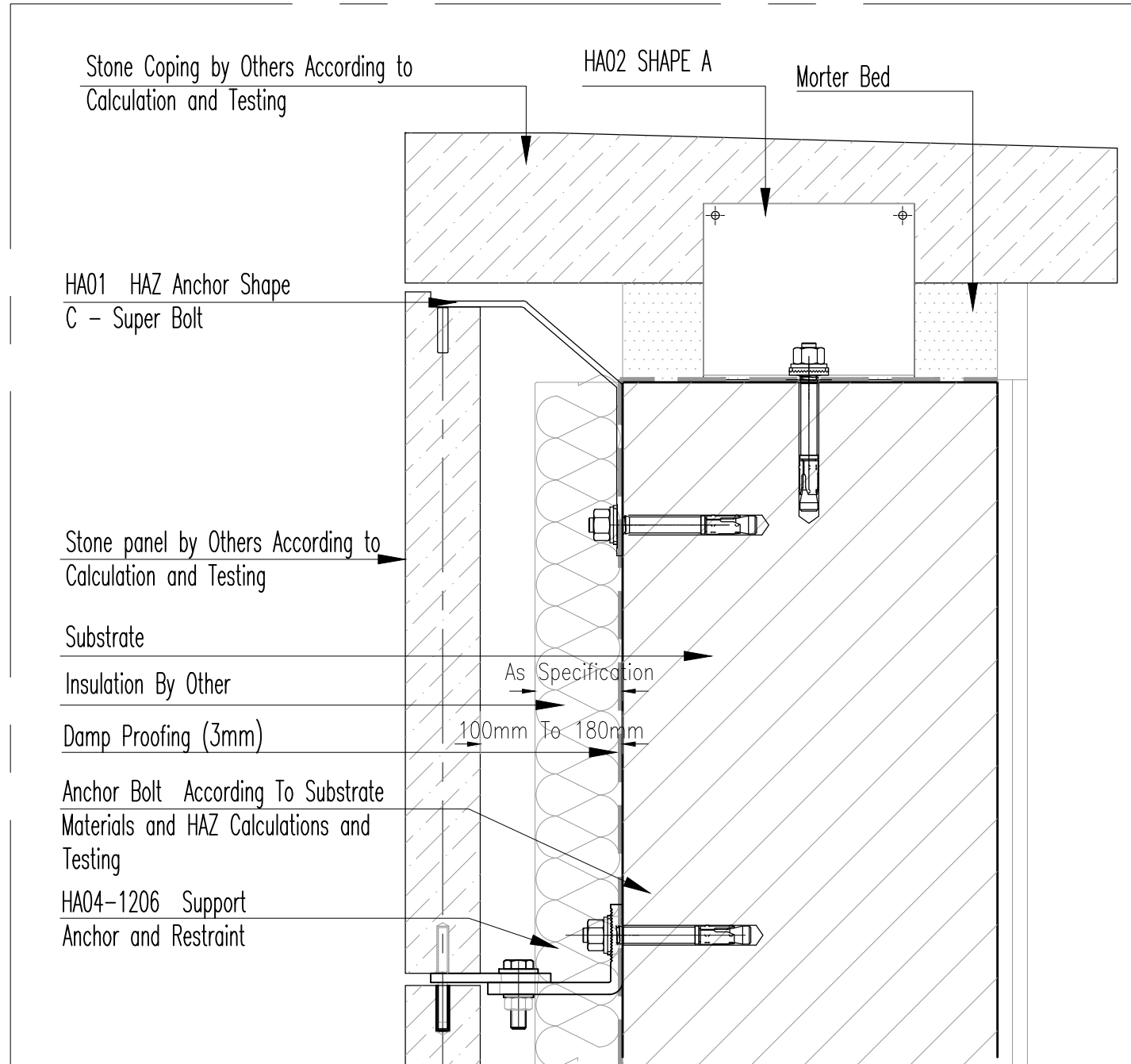

Vertical section Scale 1:4

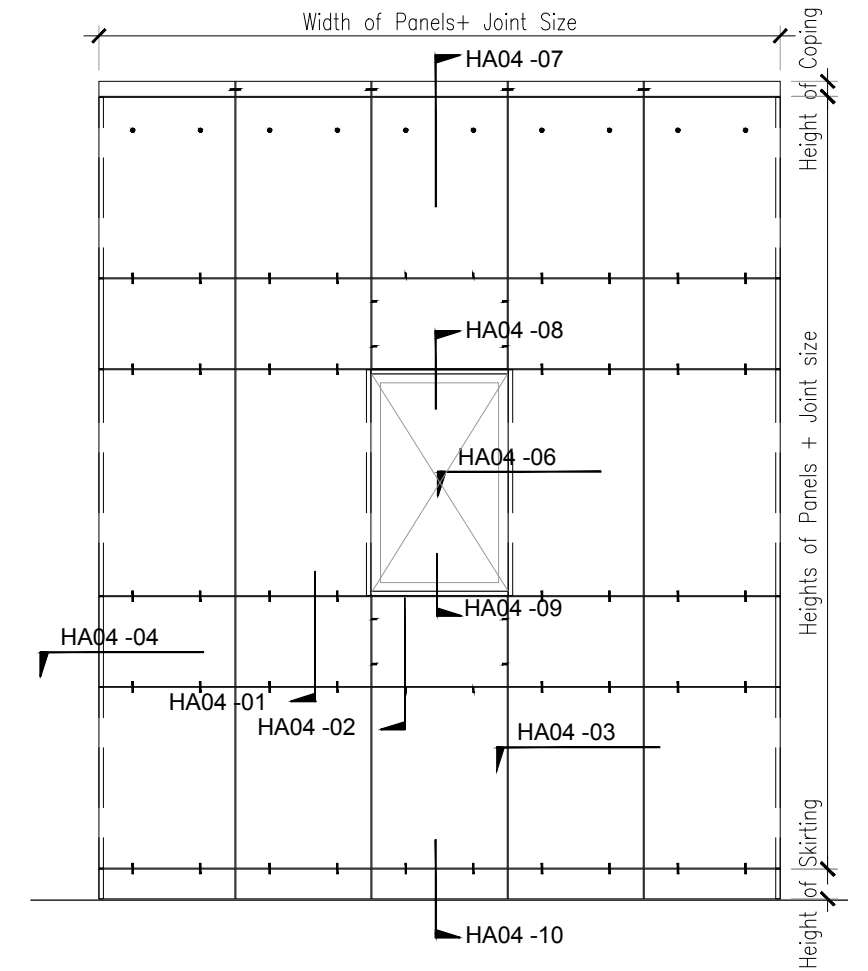

Elevation Scale 1:50



HAZ METAL Sanayi ve Ticaret A.S
 PO Box 241 31200 Iskenderun / Turkey
 Tel: +90 326 6262050 Faks: 6262045
 info@hazmetal.com / www.hazmetal.com.

Title :		Horizontal Joint Installation - Stone Coping - Vertical Section		
Drawing No.		HAZCD-HA04 - ST-008		
Series		Concept Drawings - Natural Stone Fixing System - HA04 Support Anchors		
Revision		01	scale	As Shown
				Page : 07/11

HA04

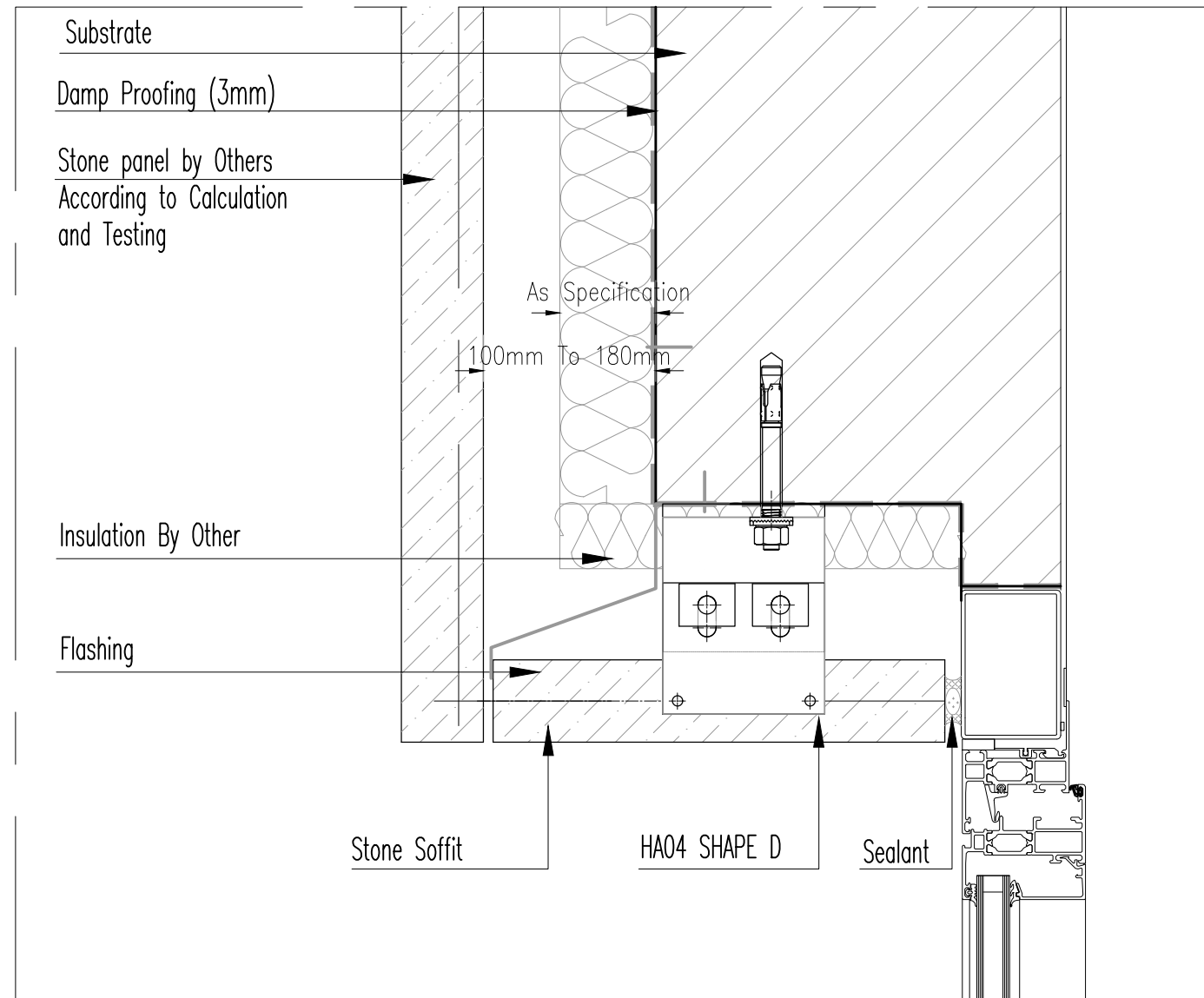

Vertical section Scale 1:4

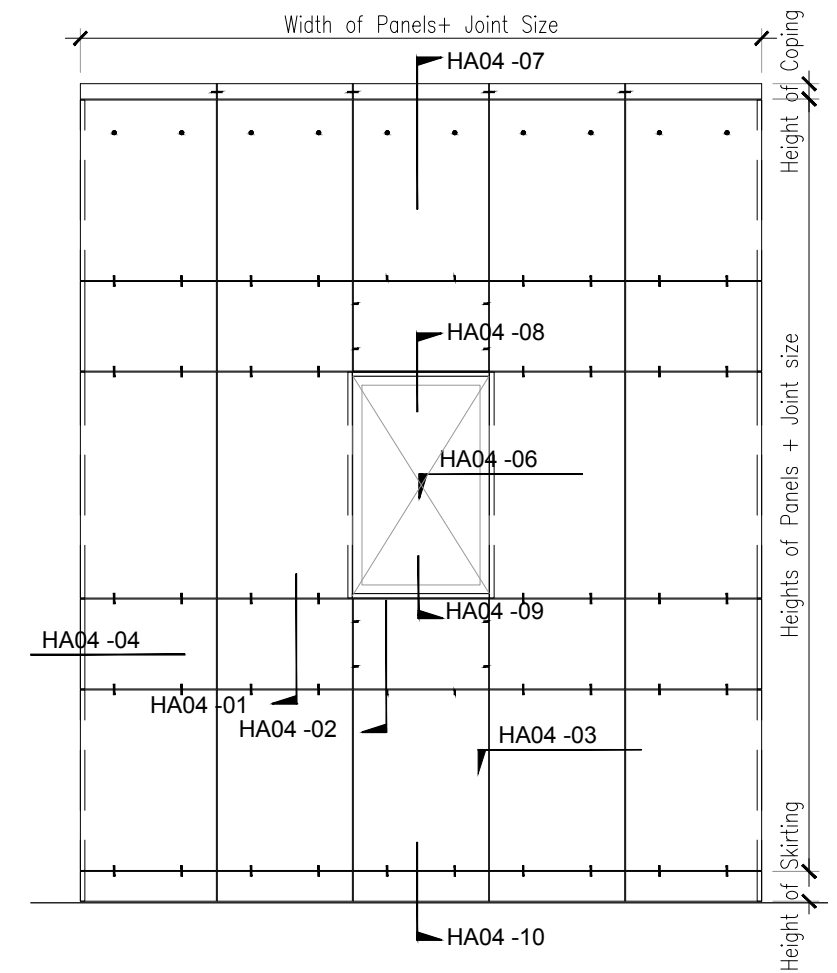

Elevation Scale 1:50



HAZ METAL Sanayi ve Ticaret A.S
 PO Box 241 31200 Iskenderun / Turkey
 Tel: +90 326 6262050 Faks: 6262045
 info@hazmetal.com / www.hazmetal.com.

Title :		Horizontal Joint Installation - Stone Soffit - Vertical Section		
Drawing No.		HAZCD-HA04 - ST-009		
Series		Concept Drawings - Natural Stone Fixing System - HA04 Support Anchors		
Revision		01	scale	As Shown
Page :				08/11

HA04

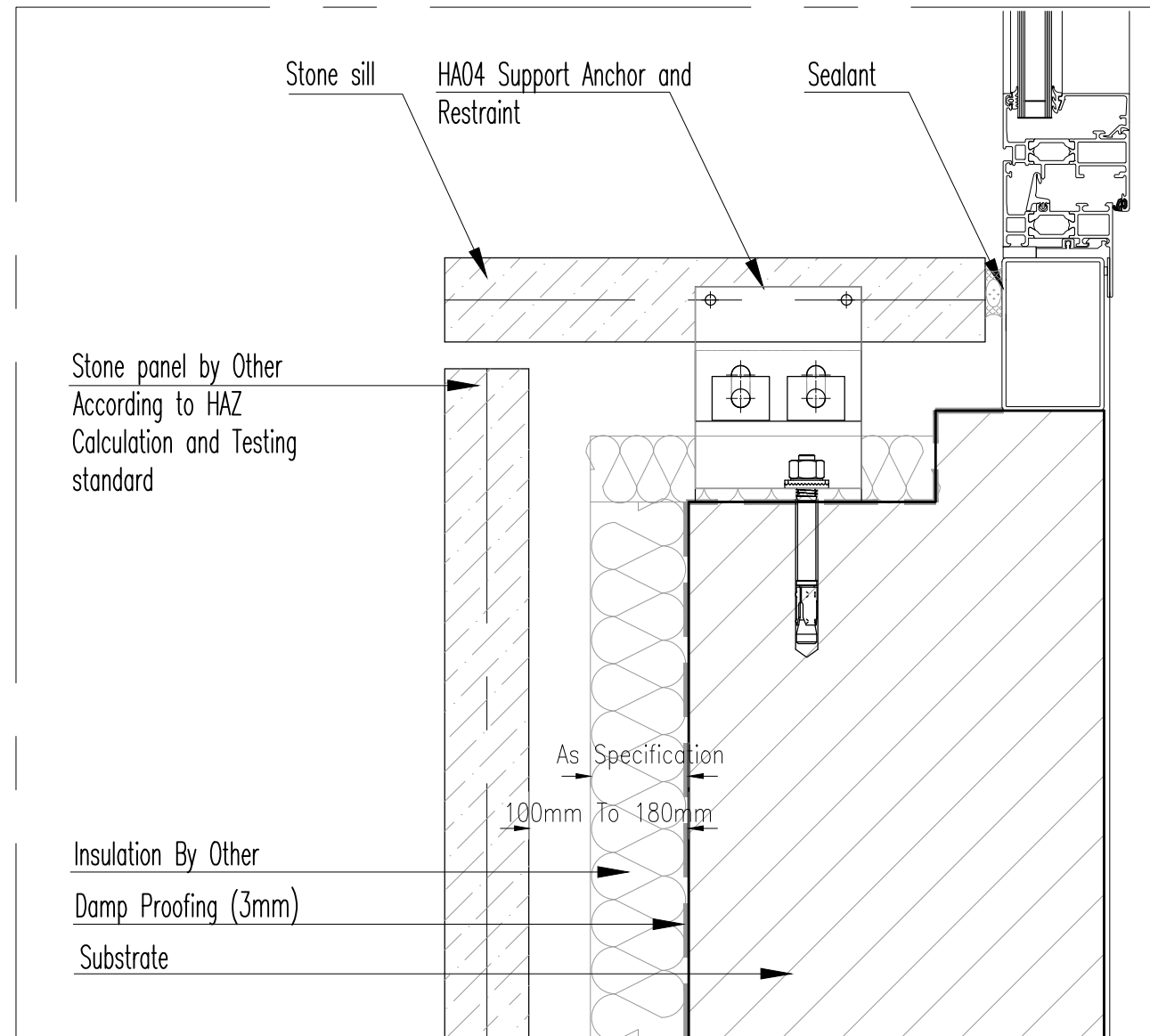

Vertical section Scale 1:4

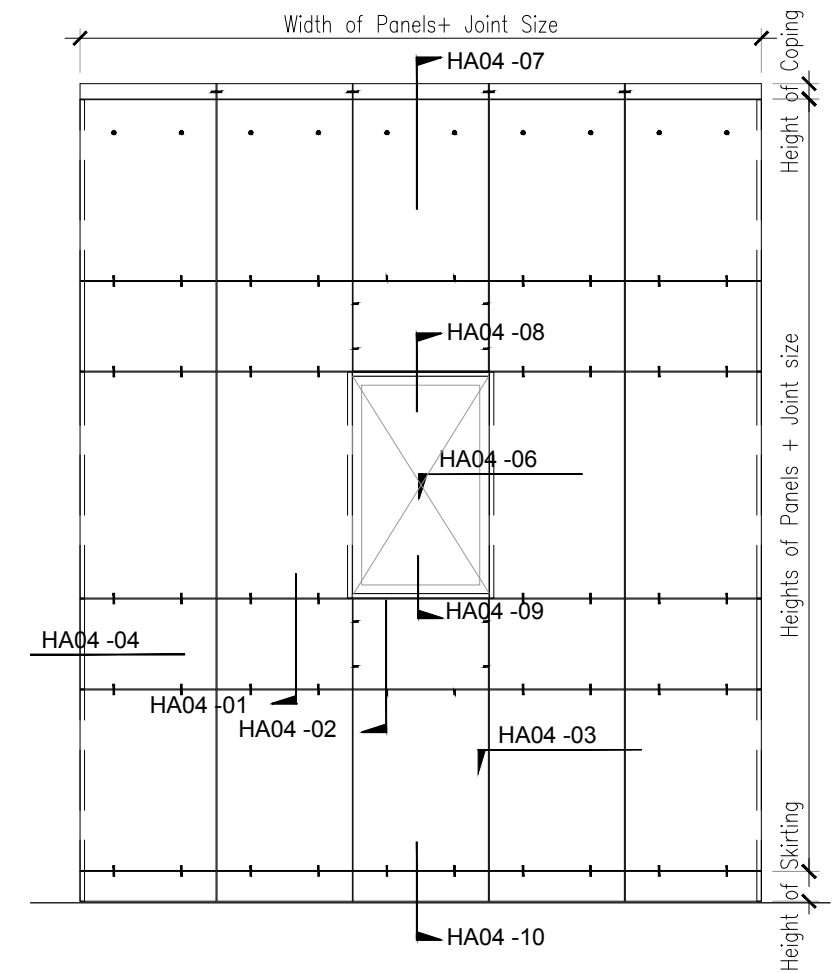

Elevation Scale 1:50



HAZ METAL Sanayi ve Ticaret A.S
 PO Box 241 31200 Iskenderun / Turkey
 Tel: +90 326 6262050 Faks: 6262045
 info@hazmetal.com / www.hazmetal.com.

Title :		Horizontal Joint Installation - Stone Sill - Vertical Section		
Drawing No.	HAZCD-HA04 - ST-010			
Series	Concept Drawings - Natural Stone Fixing System - HA04 Support Anchors			
Revision	01	scale	As Shown	Page : 09/11

HA04

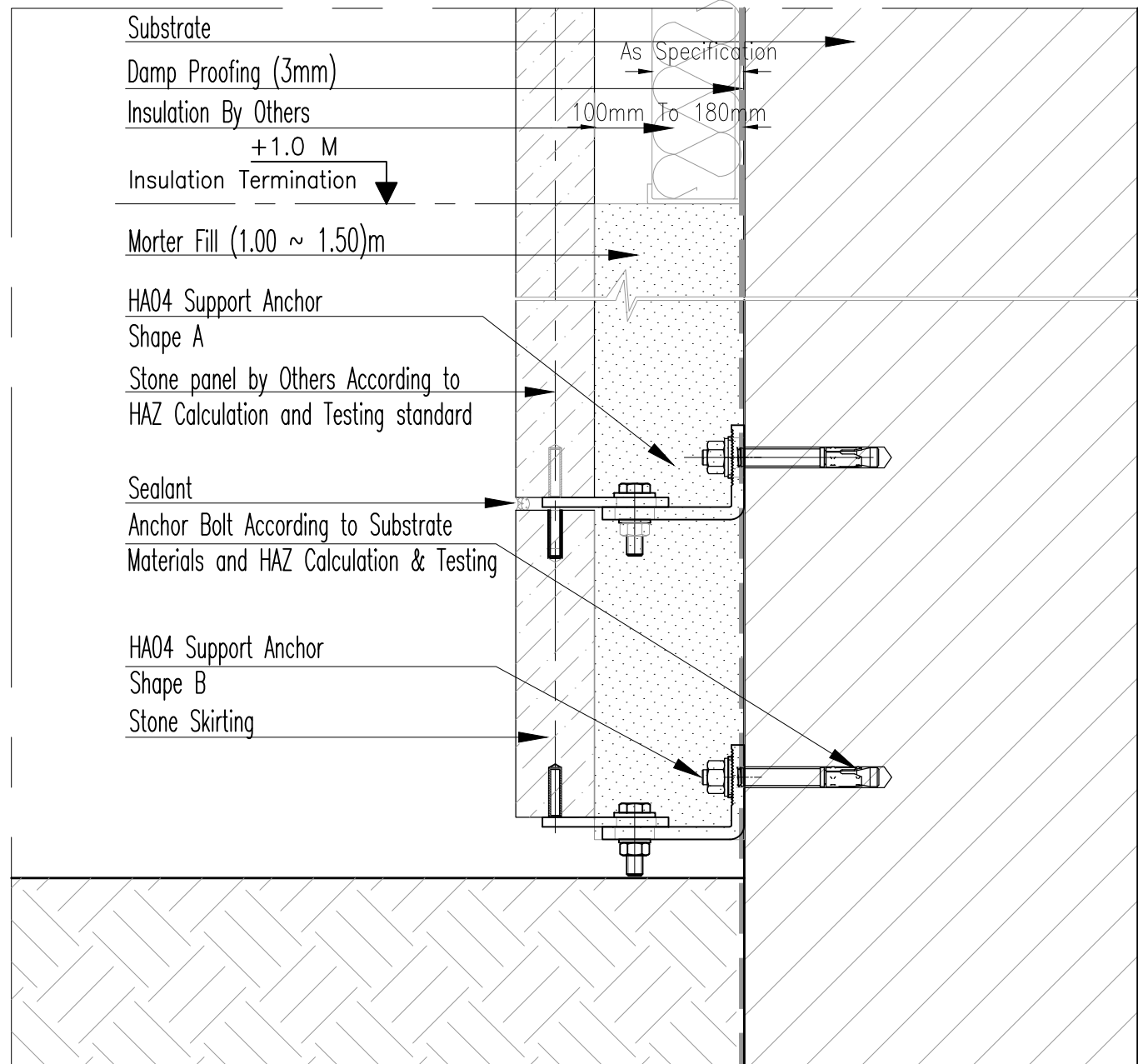

Vertical section Scale 1:4

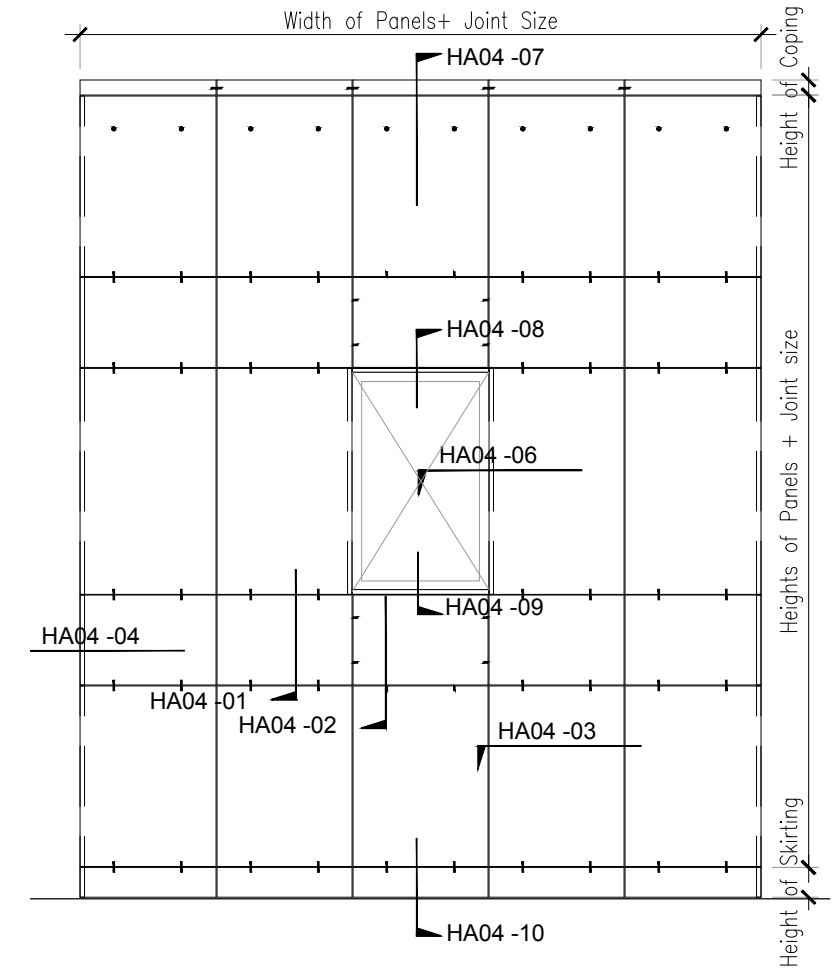

Elevation Scale 1:50



HAZ METAL Sanayi ve Ticaret A.S
 PO Box 241 31200 Iskenderun / Turkey
 Tel: +90 326 6262050 Faks: 6262045
 info@hazmetal.com / www.hazmetal.com.

Title :		Horizontal Joint Installation - Stone Skirting - Vertical Section		
Drawing No.	HAZCD-HA04 - ST-011			
Series	Concept Drawings - Natural Stone Fixing System - HA04 Support Anchors			
Revision	01	scale	As Shown	Page : 10/11

HA04

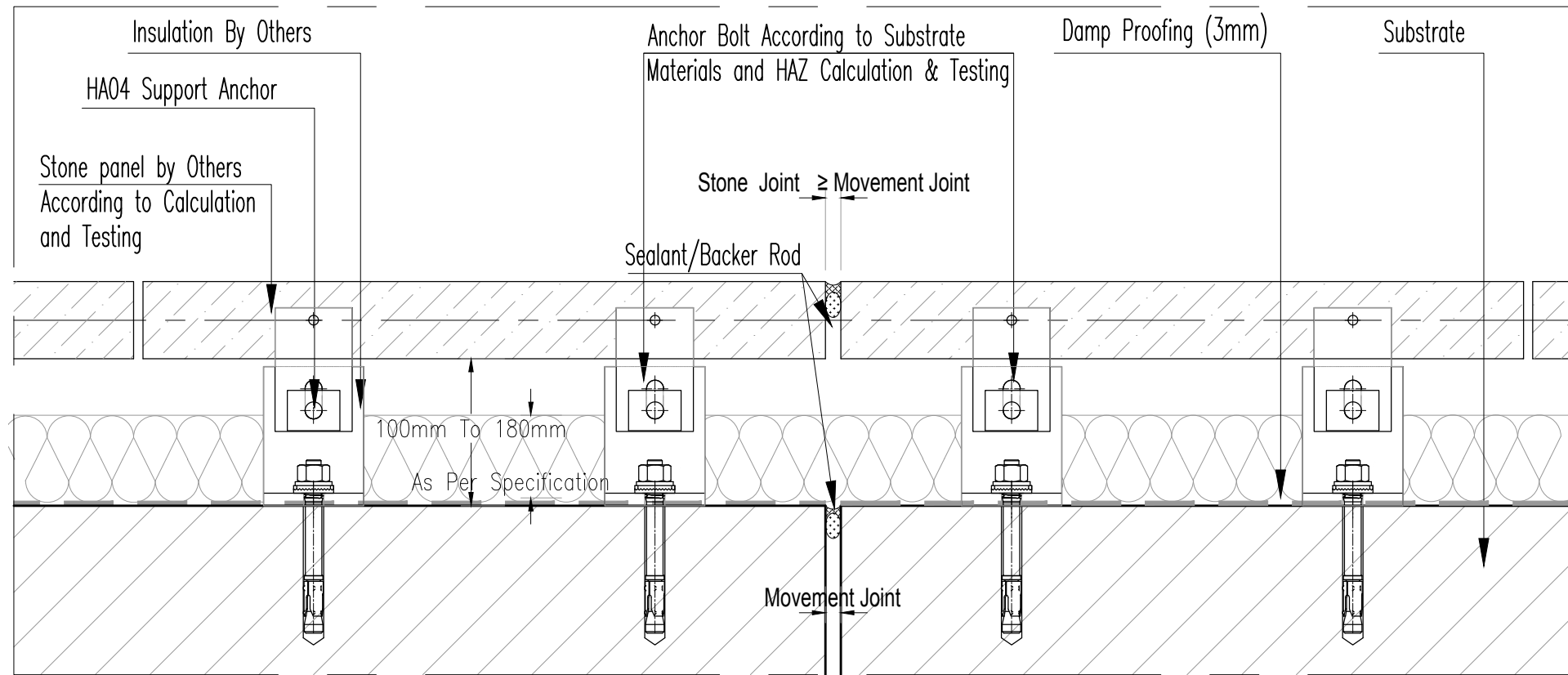

Horizontal section Scale 1:4

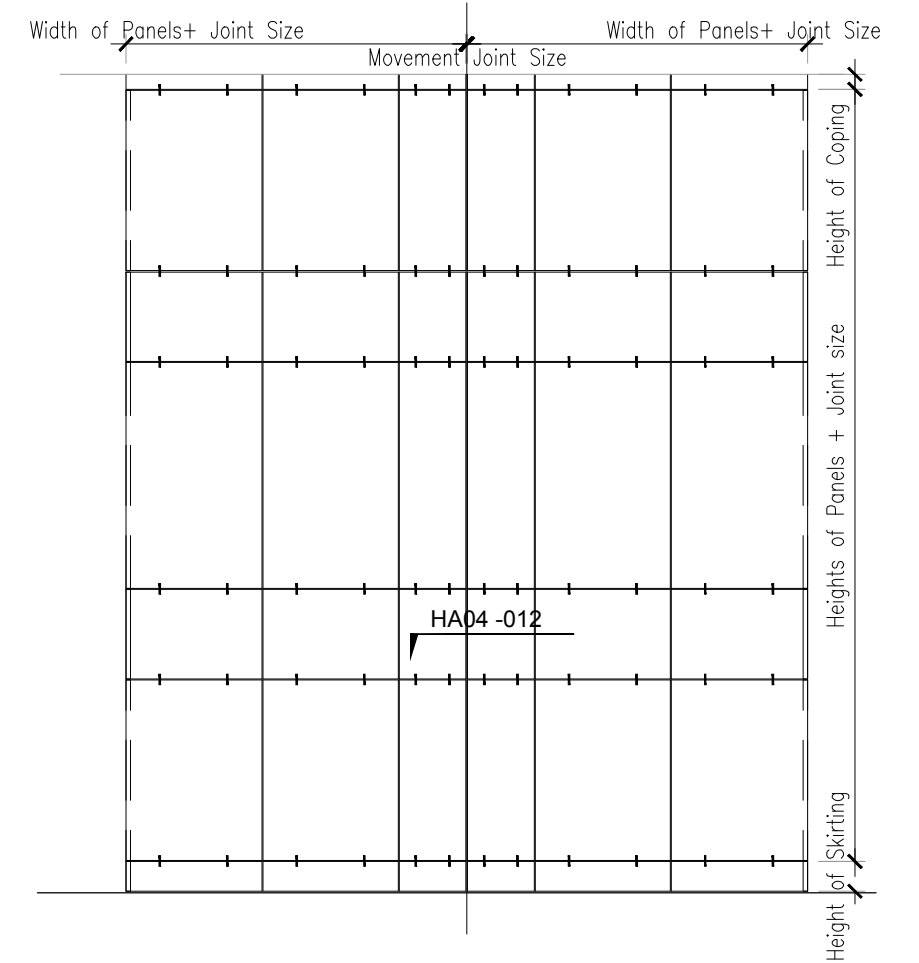

Variation on Typical Elevation
Scale 1:50



HAZ METAL Sanayi ve Ticaret A.S
PO Box 241 31200 Iskenderun / Turkey
Tel: +90 326 6262050 Faks: 6262045
info@hazmetal.com / www.hazmetal.com.

Title :		Horizontal Joint Installation - Typical Stone Claddings - Movement Joint - Horizontal Section		
Drawing No.	HAZCD-HA04 - ST-012			
Series	Concept Drawings - Natural Stone Fixing System - HA04 Support Anchors			
Revision	01	scale	As Shown	Page : 11/11