

**HAZ METAL**  
**FIXING SYSTEMS**

**HA01**

HA L ANCHOR FIXING SYSTEM

**Concept Drawings**

Series: HAZCD-HA01-ST

Direct Fixing System For Rain Screen  
Stone Cladding System for Installation at  
Horizontal Joints

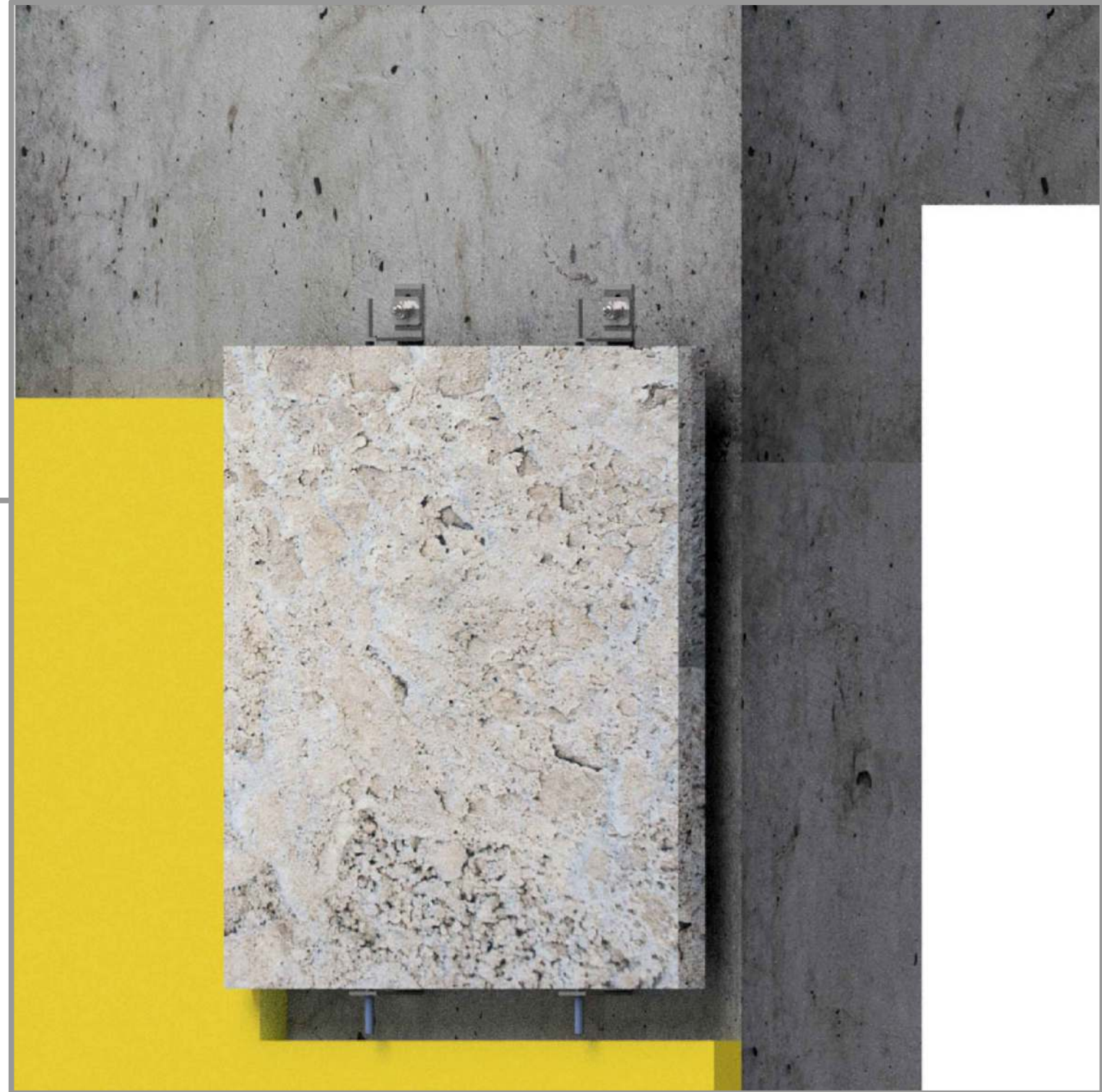

# HA01

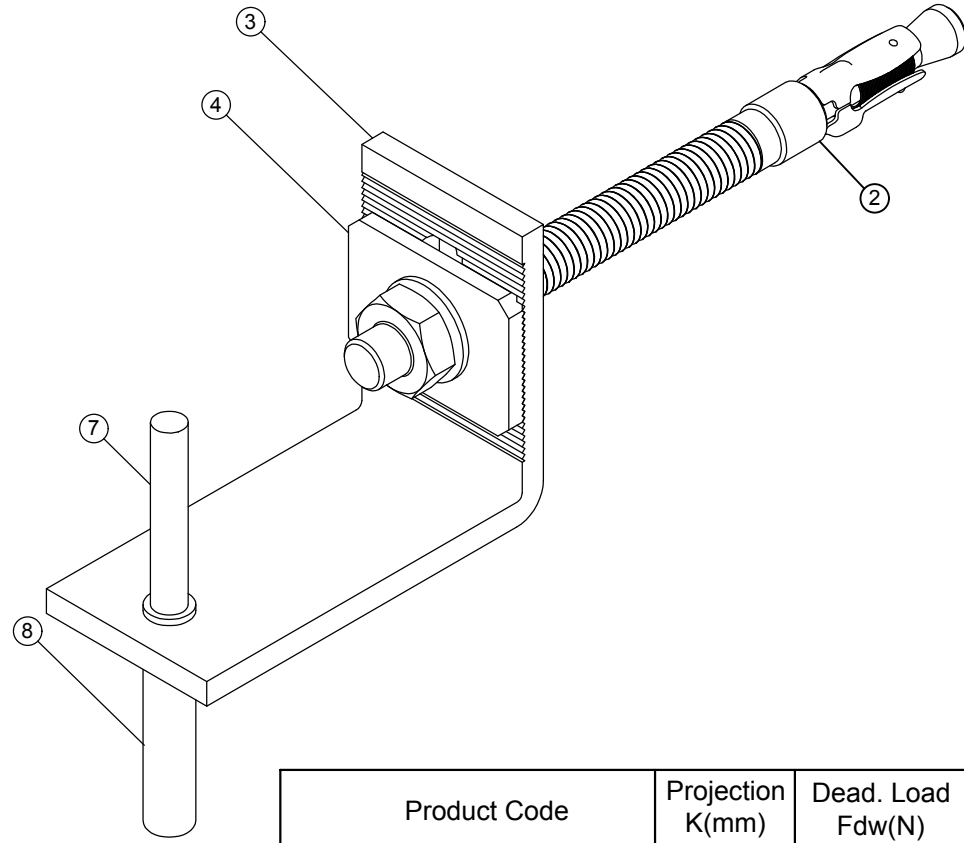

| Legend |                      |
|--------|----------------------|
| 1      | Substrate            |
| 2      | Anchor Bolt          |
| 3      | HA01-554 Anchor Body |
| 4      | Serrated Washer      |
| 5      | Stone Cladding Panel |
| 6      | Cavity               |
| 7      | FLANGED PIN          |
| 8      | PLASTIC TUBE         |

| Product Code | Projection K(mm) | Dead. Load Fdw(N) | Forming Size F(mm) | Wind Load Fh(N) | Expansion Bolt Size (mm) | Anchor Thickness T Size (mm) |
|--------------|------------------|-------------------|--------------------|-----------------|--------------------------|------------------------------|
| HA01-302     | 30               | 200               | F36                | 219             | M8X80                    | 2.5                          |
| HA01-352     | 35               | 200               | F41                | 219             | M8X80                    | 2.5                          |
| HA01-402     | 40               | 200               | F46                | 219             | M8X80                    | 3                            |
| HA01-452     | 45               | 200               | F57                | 219             | M8X80                    | 3                            |
| HA01-502     | 50               | 200               | F56                | 219             | M8X80                    | 3                            |
| HA01-552     | 55               | 200               | F61                | 219             | M8X80                    | 3                            |
| HA01-304     | 30               | 400               | F36                | 437             | M8X80                    | 3                            |
| HA01-354     | 35               | 400               | F41                | 437             | M8X80                    | 3                            |
| HA01-404     | 40               | 400               | F46                | 437             | M8X80                    | 4                            |
| HA01-454     | 45               | 400               | F57                | 437             | M8X80                    | 4                            |
| HA01-504     | 50               | 400               | F56                | 437             | M8X80                    | 4                            |
| HA01-554     | 55               | 400               | F61                | 437             | M8X80                    | 4                            |

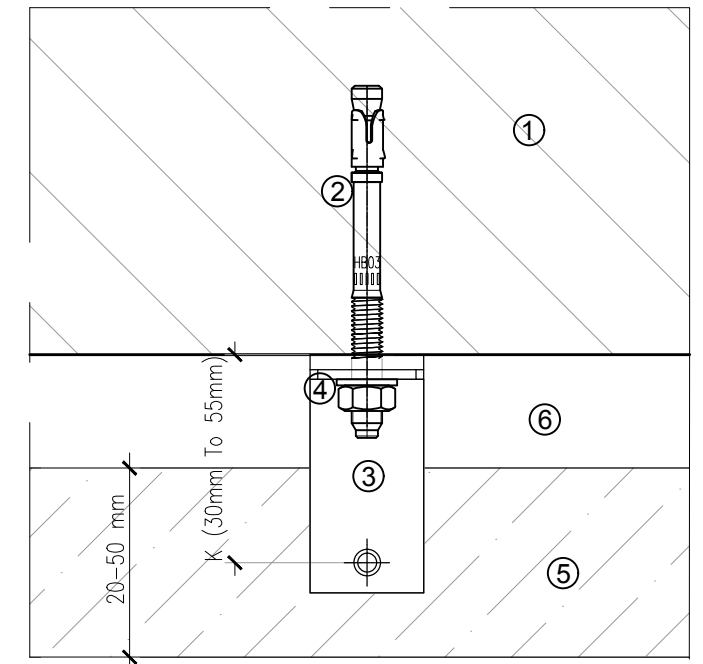

Horizontal Section Scale 1:2

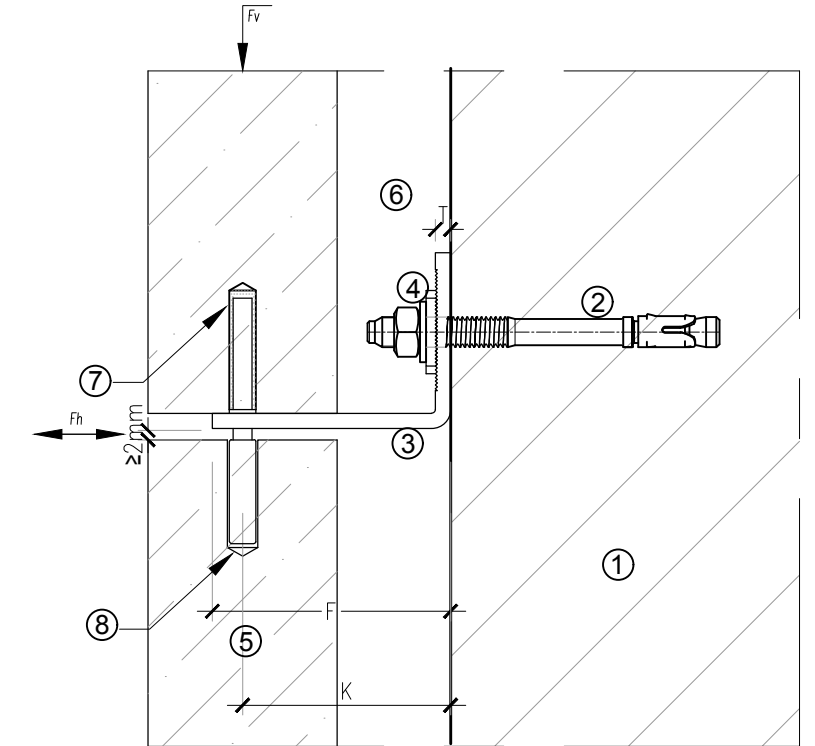

Vertical section Scale 1:2



HAZ METAL Sanayi ve Ticaret A.S  
PO Box 241 31200 Iskenderun / Turkey  
Tel: +90 326 6262050 Faks: 6262045  
info@hazmetal.com / www.hazmetal.com.

Title : Natural Stone Facade - Built-up Cavity Wall - System HA01-554 Specification

Drawing No. HAZCD-HA01-ST-001

Series Concept Drawings - Natural Stone Fixing System - HA01-554 Support Anchors

Revision 01 scale As Shown

Page : 01/11

# HA01

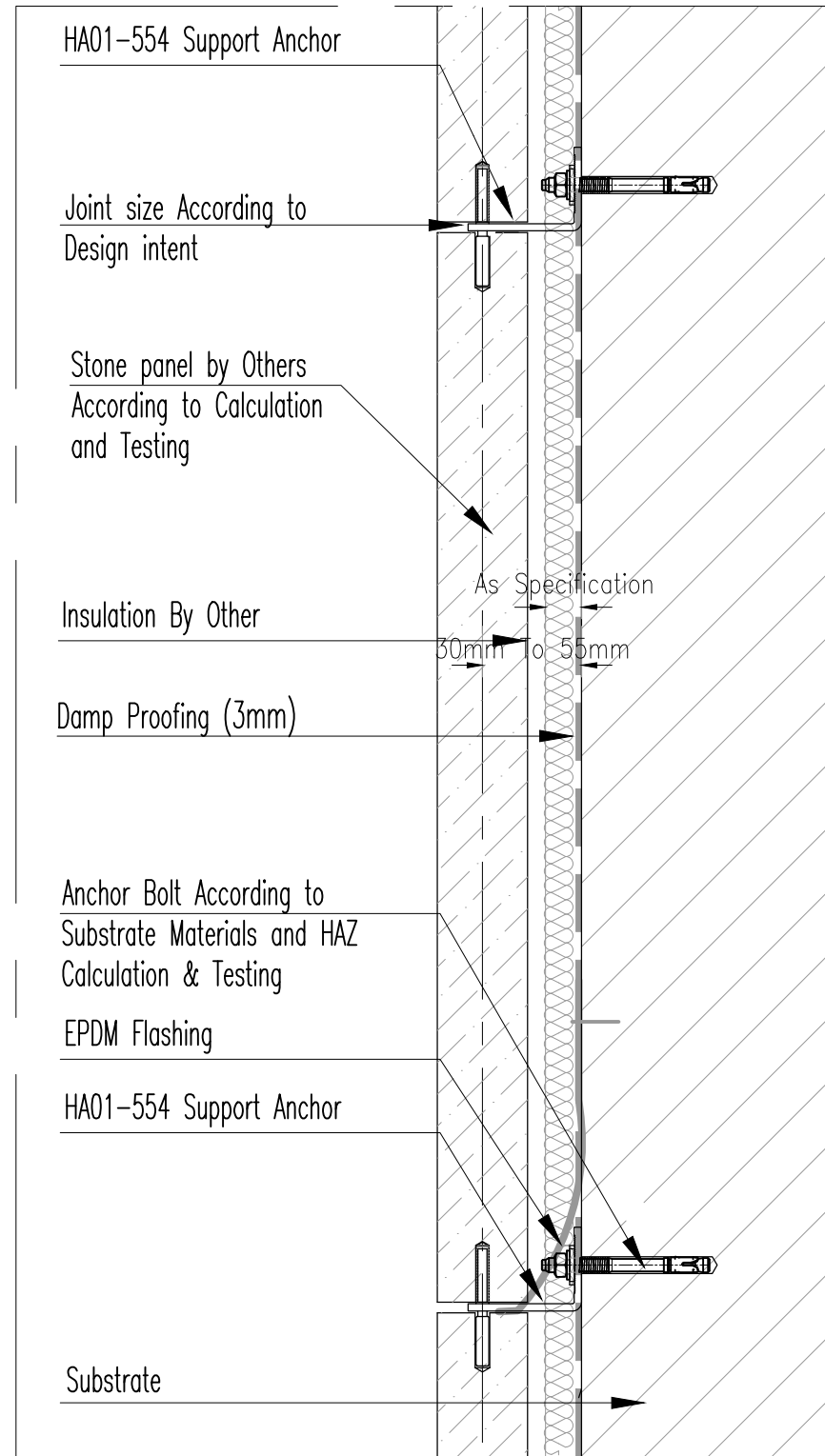

Vertical section Scale 1:4

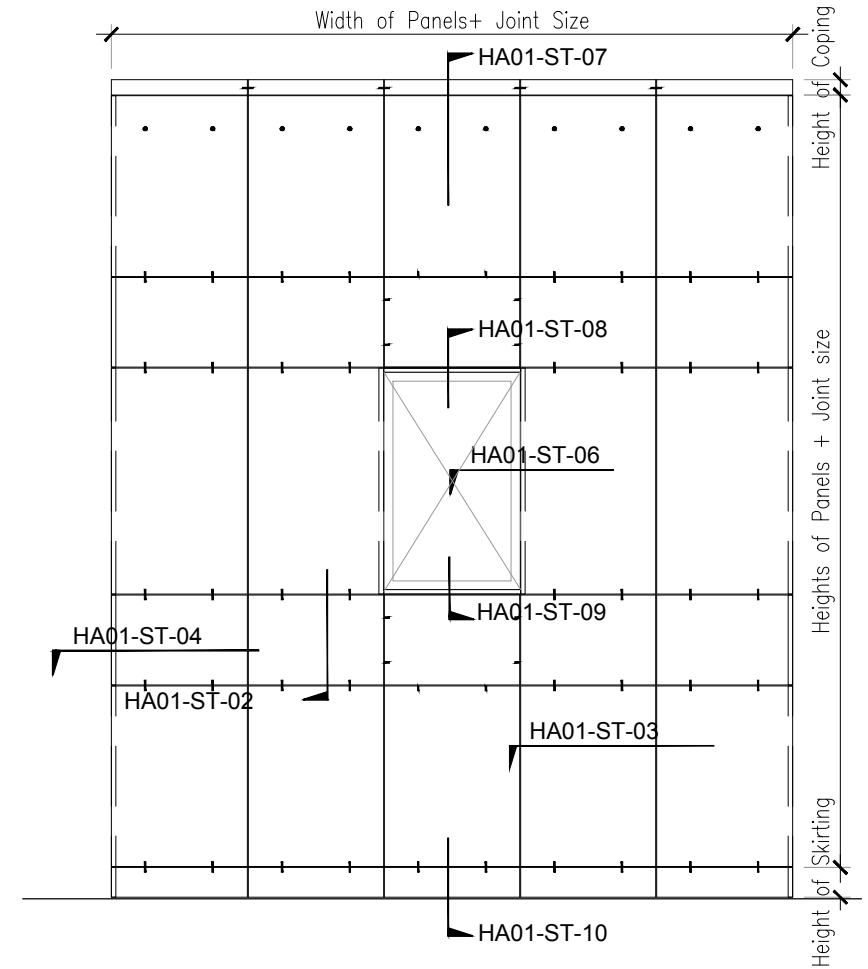

Elevation Scale 1:50



HAZ METAL Sanayi ve Ticaret A.S  
 PO Box 241 31200 Iskenderun / Turkey  
 Tel: +90 326 6262050 Faks: 6262045  
 info@hazmetal.com / www.hazmetal.com.

|             |   |  |          |              |
|-------------|---|--|----------|--------------|
| Title :     |   | Horizontal Joint Installation - Typical Stone Claddings / Rain Screen - Vertical Section |          |              |
| Drawing No. | HAZCD-HA01-ST-002   |  |          |              |
| Series      | Concept Drawings - Natural Stone Fixing System - HA01-554 Support Anchors |  |          |              |
| Revision    | 01  | scale  | As Shown | Page : 02/11 |

# HA01

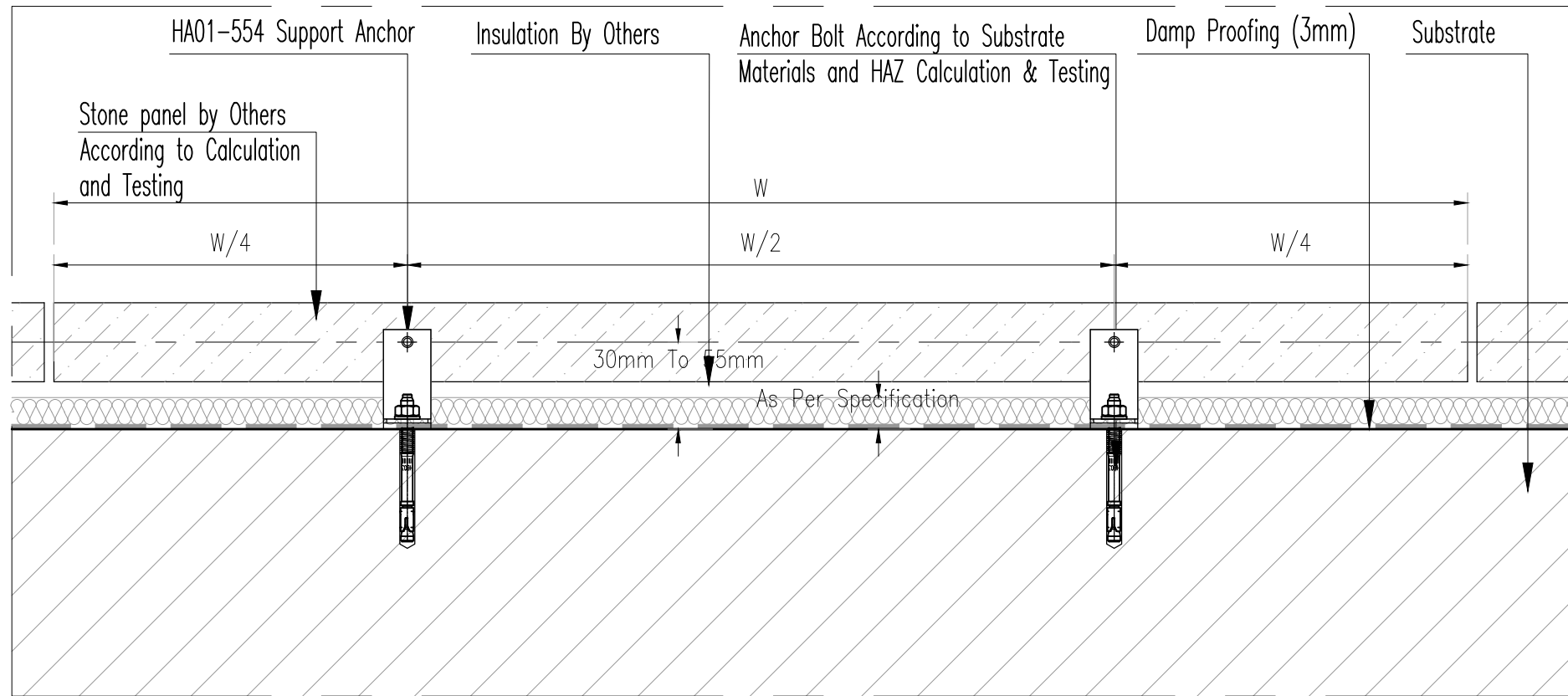

Horizontal section Scale 1:4

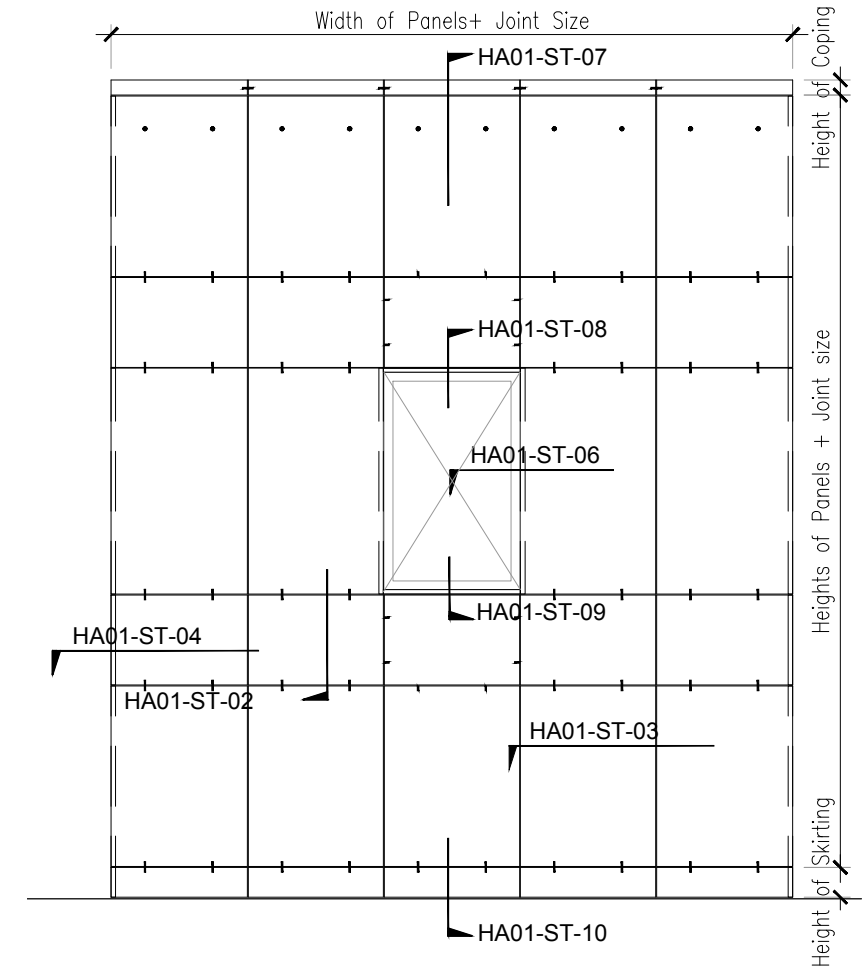

Elevation Scale 1:50



HAZ METAL Sanayi ve Ticaret A.S  
 PO Box 241 31200 Iskenderun / Turkey  
 Tel: +90 326 6262050 Faks: 6262045  
 info@hazmetal.com / www.hazmetal.com.

|             |   |  |          |              |
|-------------|---|--|----------|--------------|
| Title :     |   | Horizontal Joint Installation - Typical Stone Claddings / Rain Screen - Horizontal Section |          |              |
| Drawing No. | HAZCD-HA01-ST-003   |  |          |              |
| Series      | Concept Drawings - Natural Stone Fixing System - HA01-554 Support Anchors |  |          |              |
| Revision    | 01  | scale  | As Shown | Page : 03/11 |



# HA01

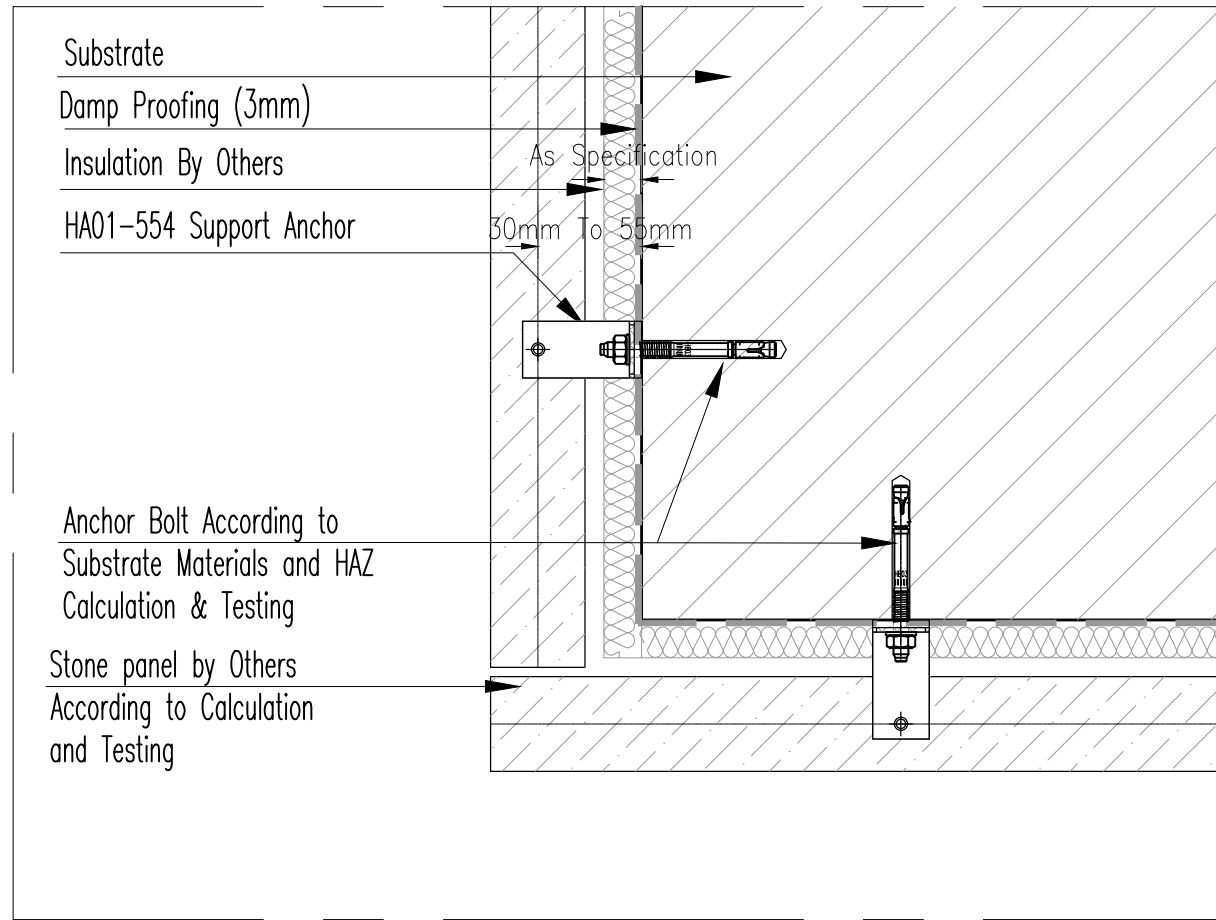

Horizontal section Scale 1:4

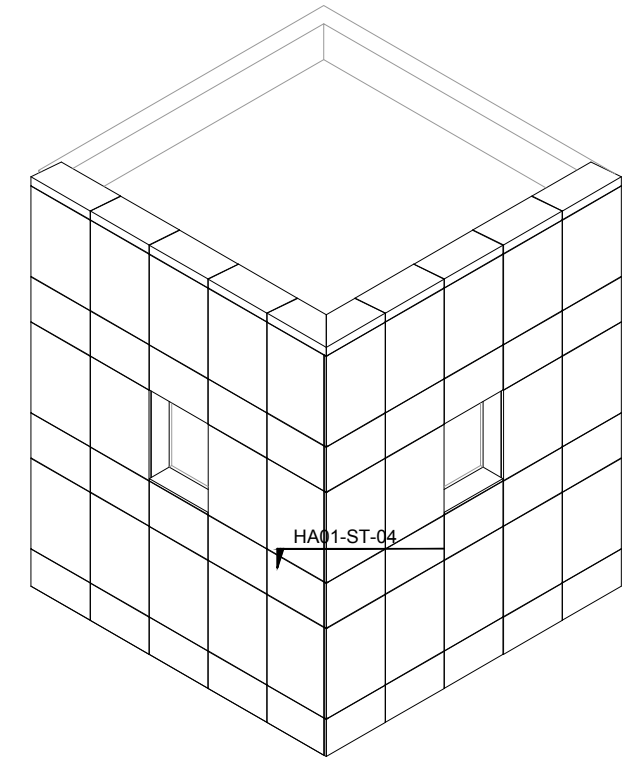

Isometric Scale 1:100



HAZ METAL Sanayi ve Ticaret A.S  
 PO Box 241 31200 Iskenderun / Turkey  
 Tel: +90 326 6262050 Faks: 6262045  
 info@hazmetal.com / www.hazmetal.com.

|             |   |   |          |              |
|-------------|---|---|----------|--------------|
| Title :     |   | Horizontal Joint Installation - External Corner Stone Cladding - Horizontal Section |          |              |
| Drawing No. | HAZCD-HA01-ST-004   |   |          |              |
| Series      | Concept Drawings - Natural Stone Fixing System - HA01-554 Support Anchors |   |          |              |
| Revision    | 01  | scale   | As Shown | Page : 04/11 |

# HA01

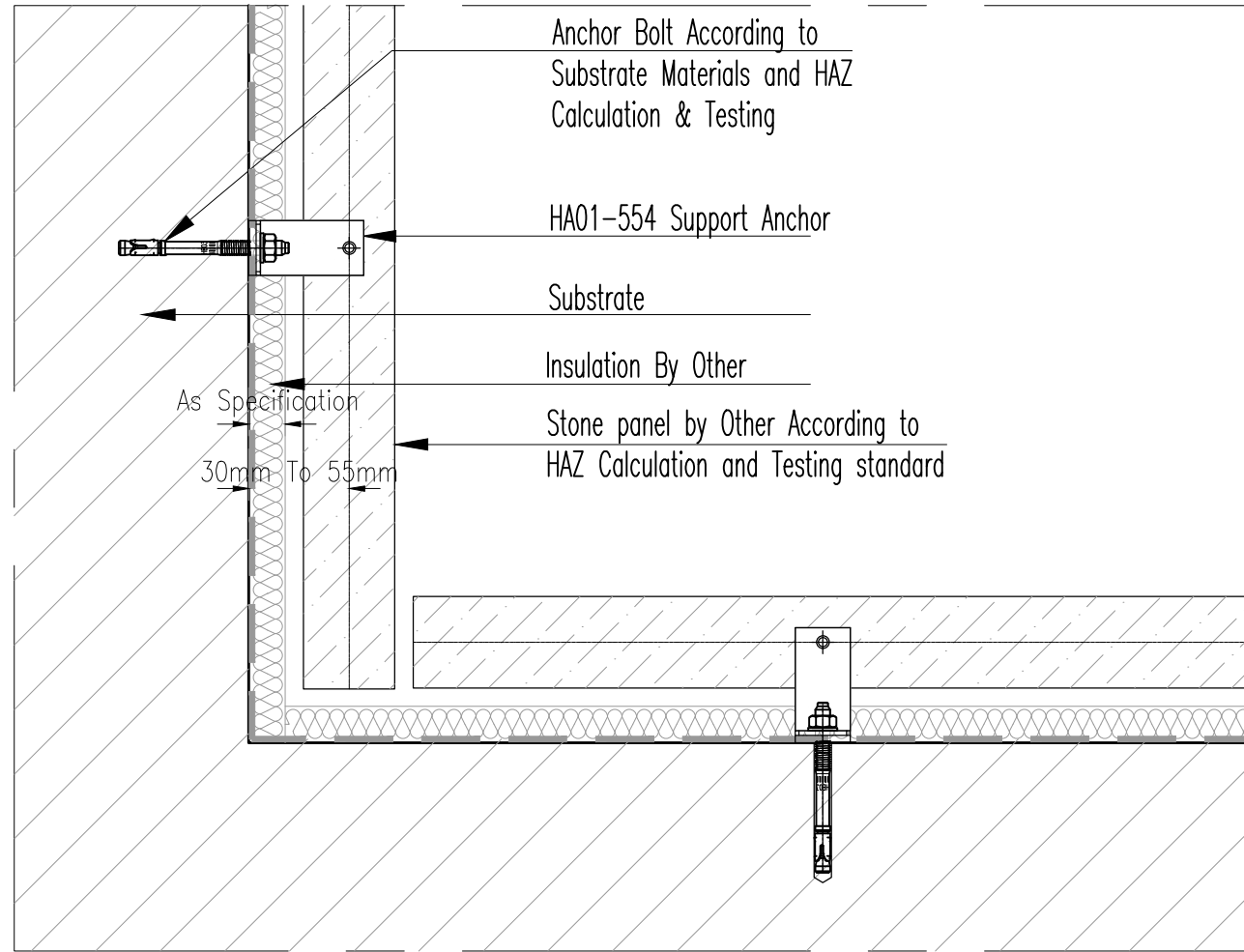

Horizontal section Scale 1:4

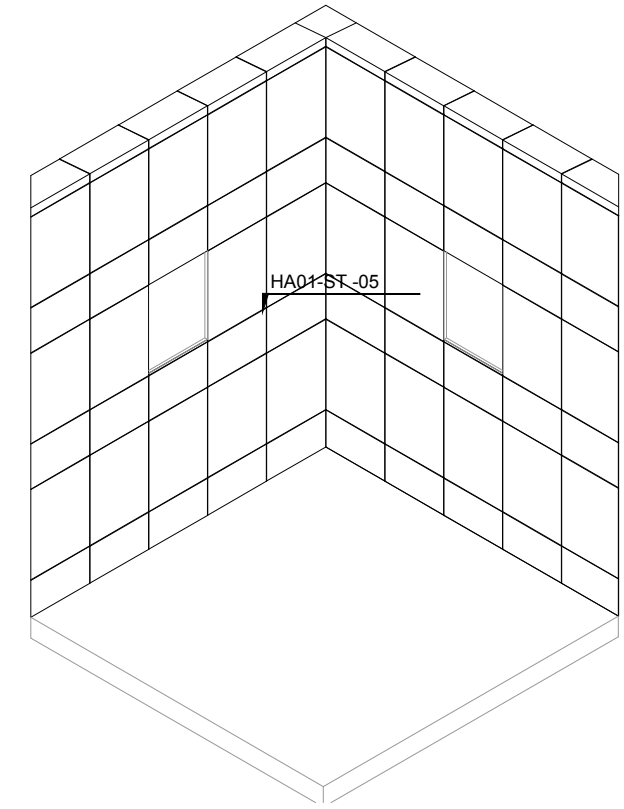

Isometric Scale 1:100



HAZ METAL Sanayi ve Ticaret A.S  
 PO Box 241 31200 Iskenderun / Turkey  
 Tel: +90 326 6262050 Faks: 6262045  
 info@hazmetal.com / www.hazmetal.com.

|             |   |   |          |              |
|-------------|---|---|----------|--------------|
| Title :     |   | Horizontal Joint Installation - Internal Corner Stone Cladding - Horizontal Section |          |              |
| Drawing No. | HAZCD-HA01-ST-005   |   |          |              |
| Series      | Concept Drawings - Natural Stone Fixing System - HA01-554 Support Anchors |   |          |              |
| Revision    | 01  | scale   | As Shown | Page : 05/11 |

# HA01

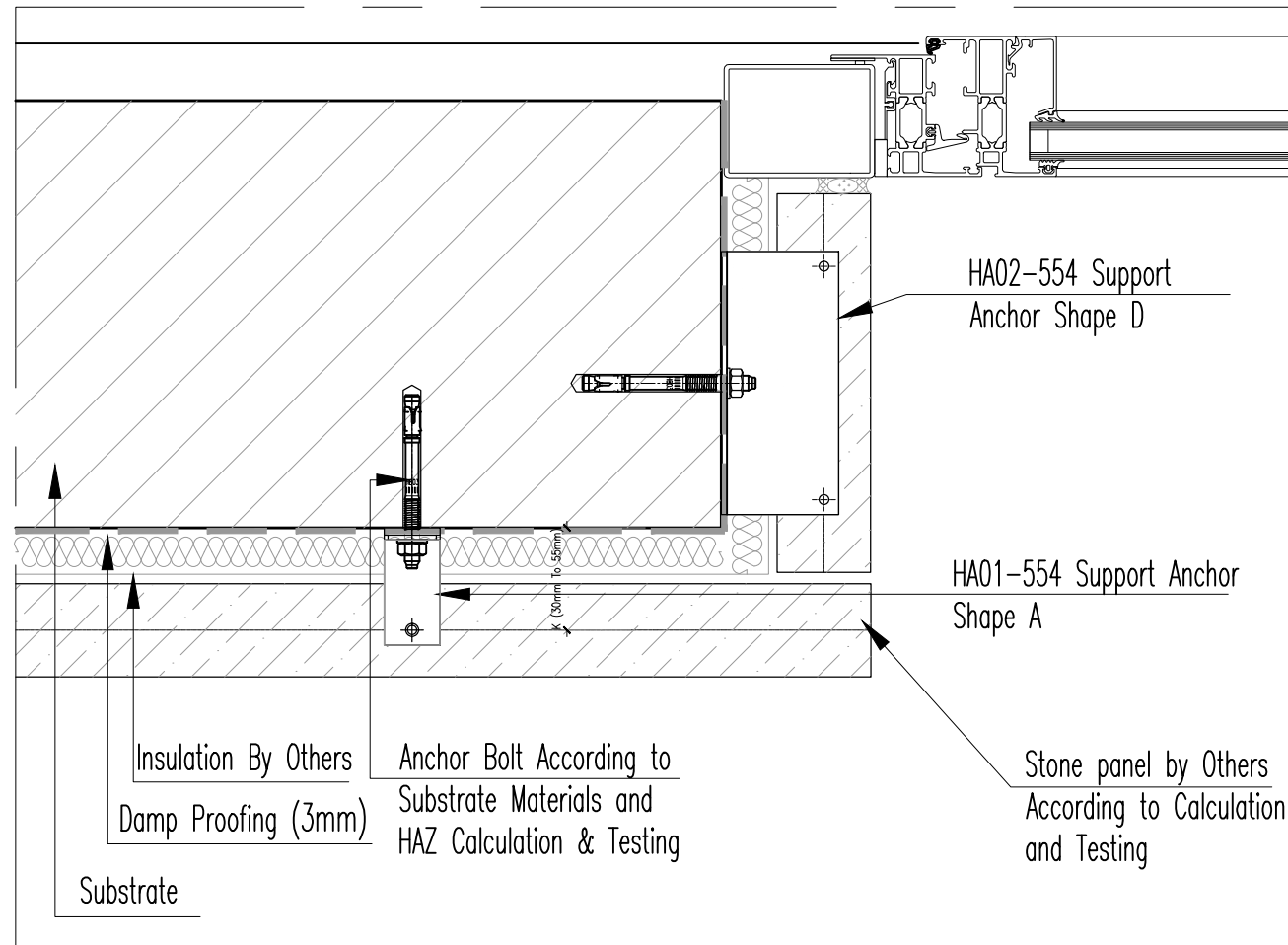

Horizontal section Scale 1:4

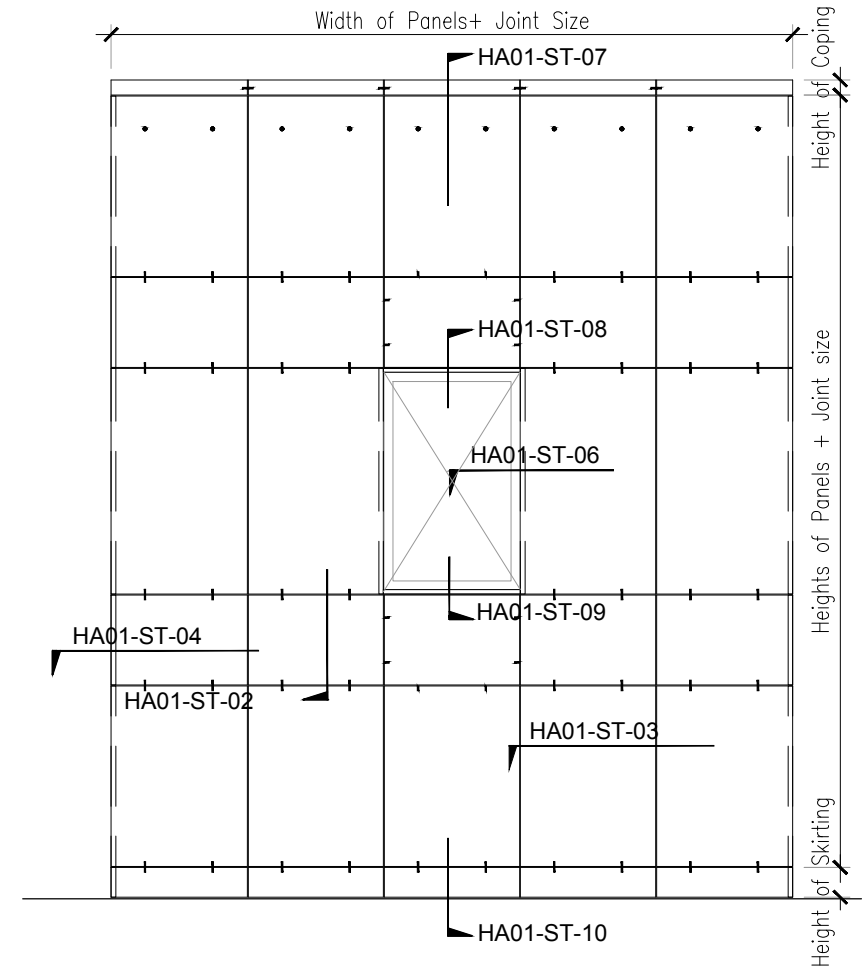

Elevation Scale 1:50



HAZ METAL Sanayi ve Ticaret A.S  
 PO Box 241 31200 Iskenderun / Turkey  
 Tel: +90 326 6262050 Faks: 6262045  
 info@hazmetal.com / www.hazmetal.com.

|             |   |   |          |              |
|-------------|---|---|----------|--------------|
| Title :     |   | Horizontal Joint Installation - Stone Reveal - Horizontal Section |          |              |
| Drawing No. | HAZCD-HA01-ST-006   |   |          |              |
| Series      | Concept Drawings - Natural Stone Fixing System - HA01-554 Support Anchors |   |          |              |
| Revision    | 01  | scale   | As Shown | Page : 06/11 |

# HA01

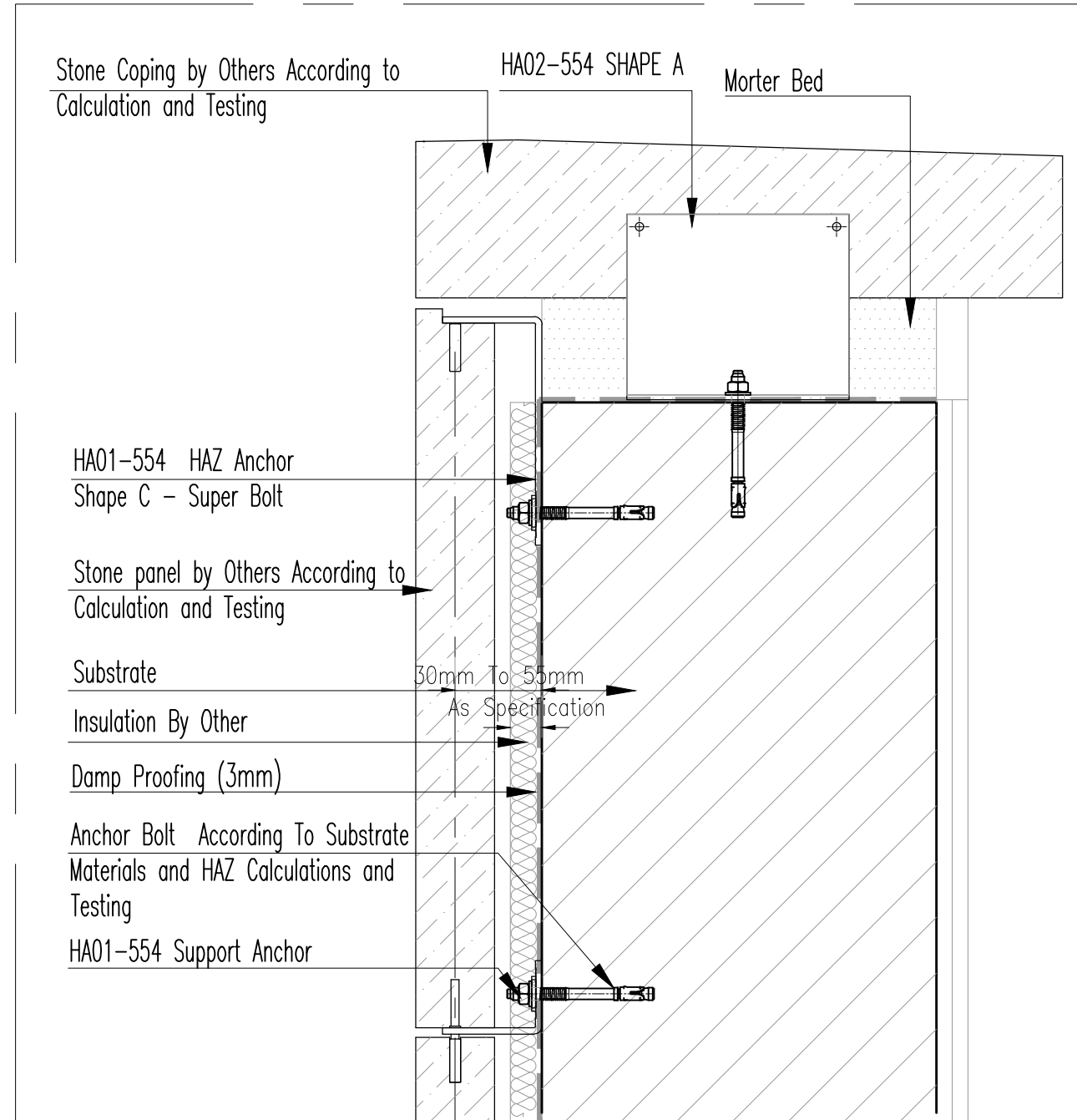

Vertical section Scale 1:4

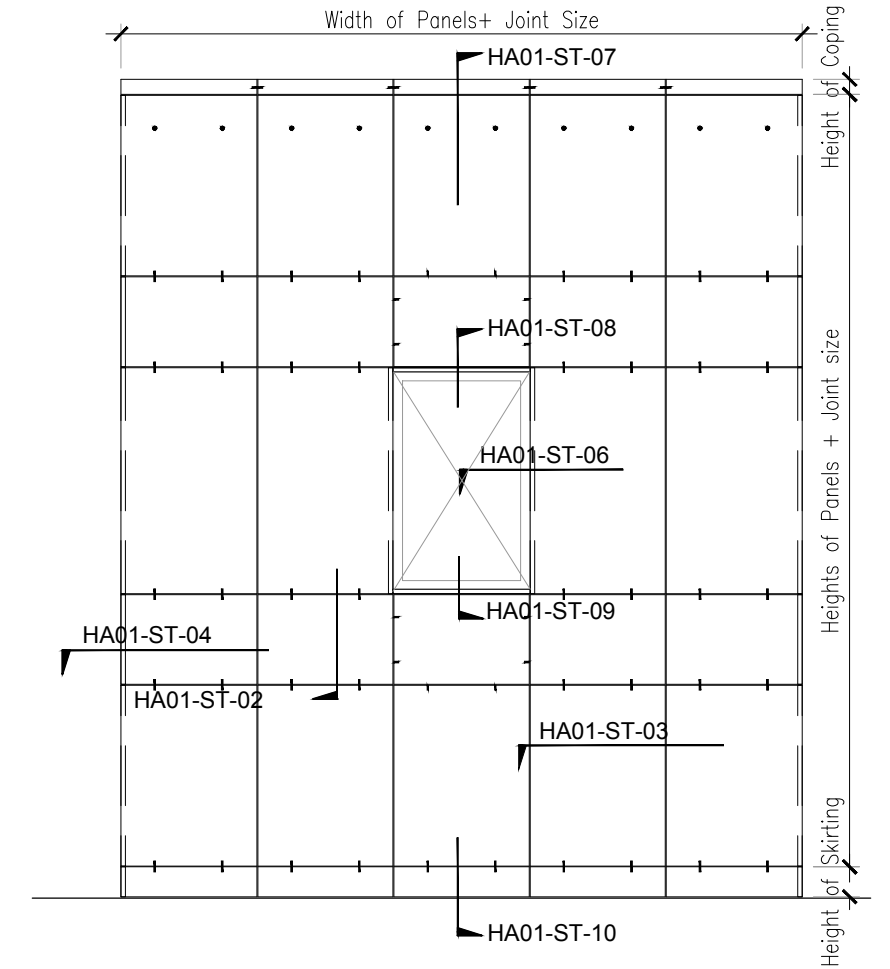

Elevation Scale 1:50



HAZ METAL Sanayi ve Ticaret A.S  
 PO Box 241 31200 Iskenderun / Turkey  
 Tel: +90 326 6262050 Faks: 6262045  
 info@hazmetal.com / www.hazmetal.com.

|             |   |   |          |              |
|-------------|---|---|----------|--------------|
| Title :     |   | Horizontal Joint Installation - Stone Coping - Vertical Section |          |              |
| Drawing No. | HAZCD-HA01-ST-007   |   |          |              |
| Series      | Concept Drawings - Natural Stone Fixing System - HA01-554 Support Anchors |   |          |              |
| Revision    | 01  | scale   | As Shown | Page : 07/11 |



# HA01

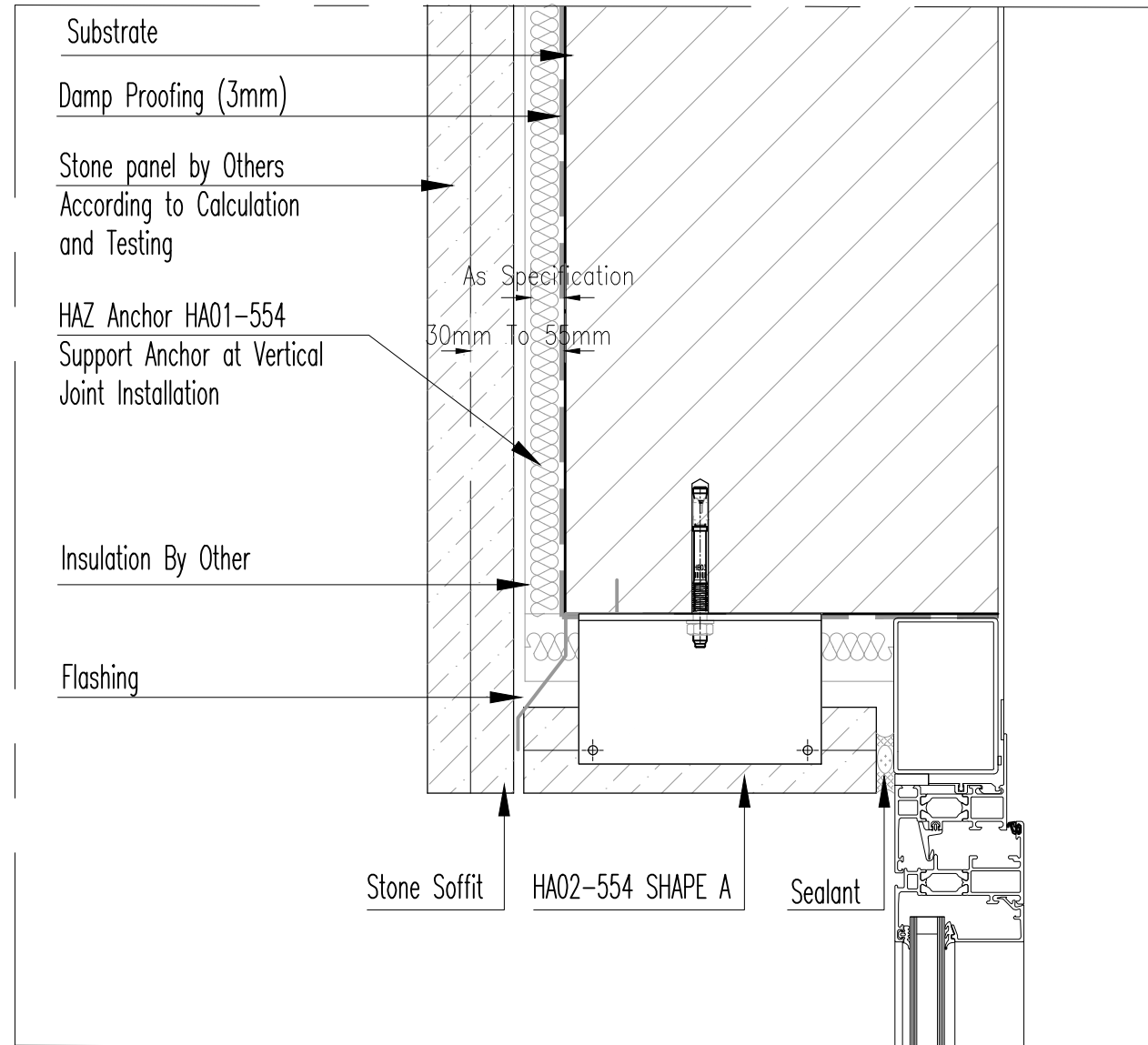

Vertical section Scale 1:4

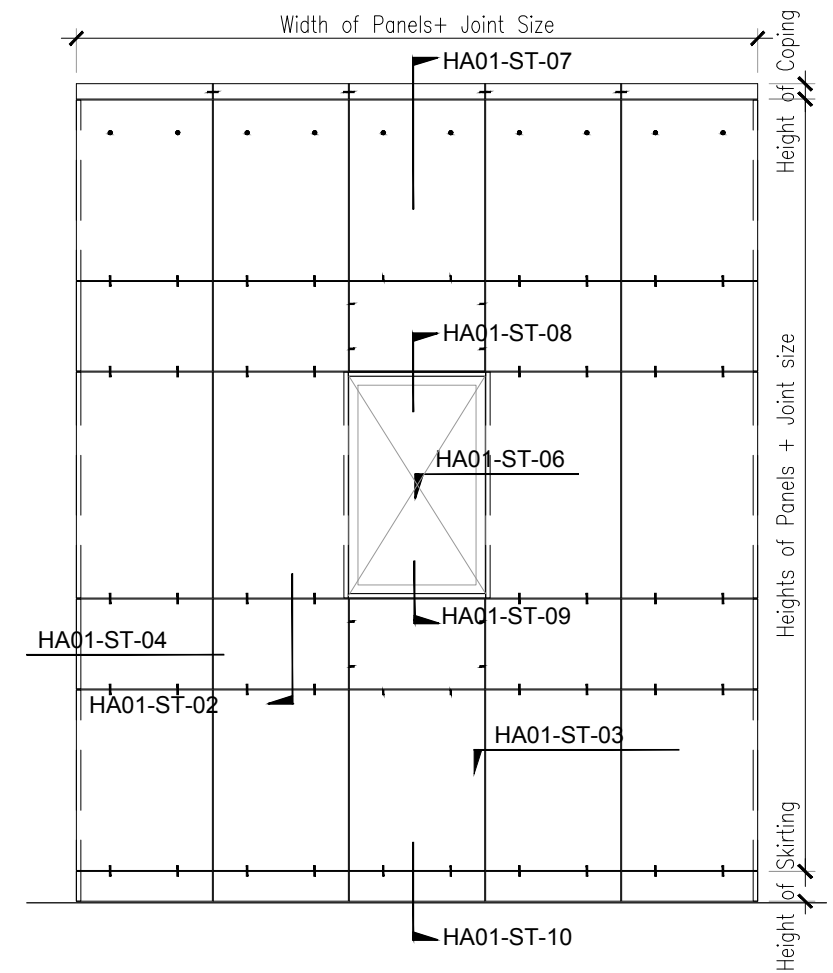

Elevation Scale 1:50



HAZ METAL Sanayi ve Ticaret A.S  
 PO Box 241 31200 Iskenderun / Turkey  
 Tel: +90 326 6262050 Faks: 6262045  
 info@hazmetal.com / www.hazmetal.com.

|             |   |   |          |              |
|-------------|---|---|----------|--------------|
| Title :     |   | Horizontal Joint Installation - Stone Soffit - Vertical Section |          |              |
| Drawing No. | HAZCD-HA01-ST-008   |   |          |              |
| Series      | Concept Drawings - Natural Stone Fixing System - HA01-554 Support Anchors |   |          |              |
| Revision    | 01  | scale   | As Shown | Page : 08/11 |

# HA01

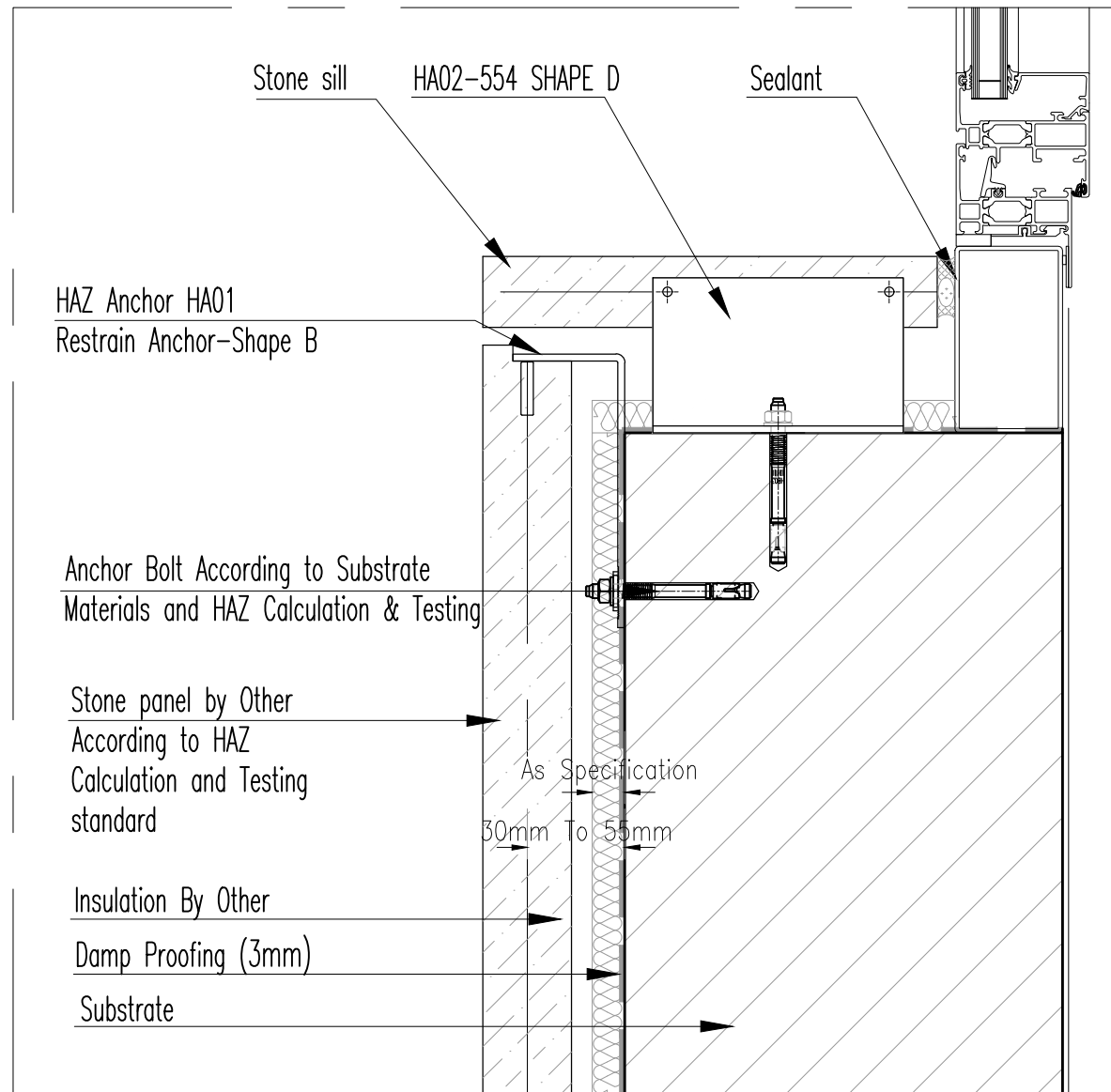

Vertical section Scale 1:4

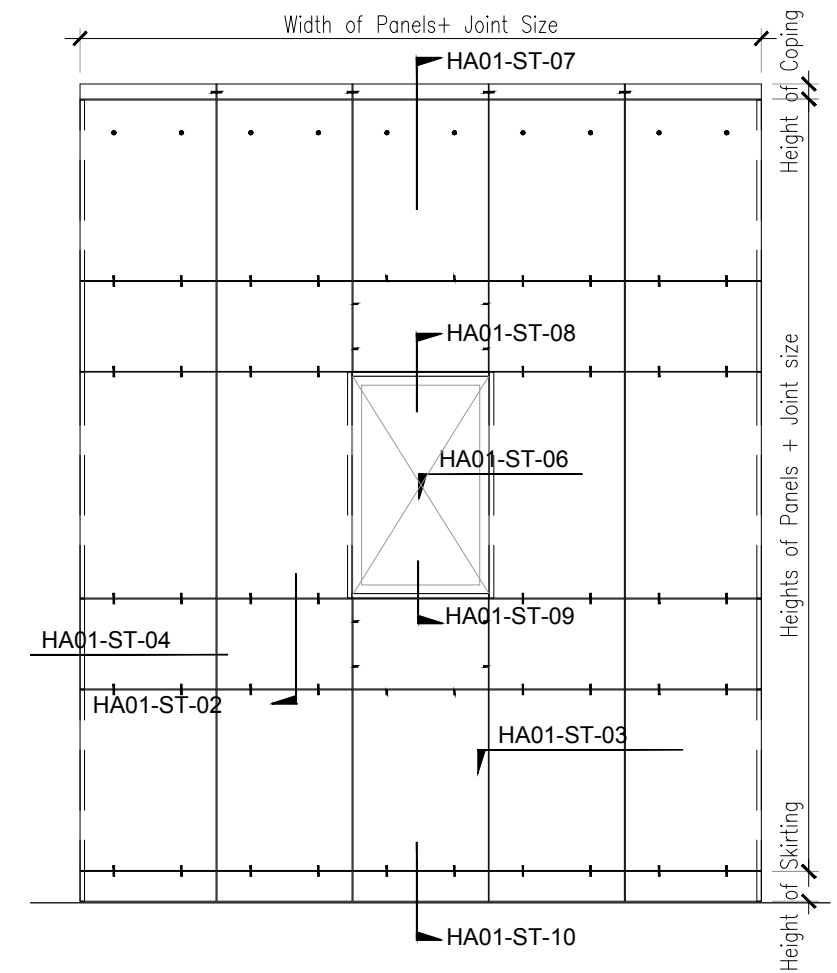

Elevation Scale 1:50



HAZ METAL Sanayi ve Ticaret A.S  
 PO Box 241 31200 Iskenderun / Turkey  
 Tel: +90 326 6262050 Faks: 6262045  
 info@hazmetal.com / www.hazmetal.com.

|             |   |   |          |              |
|-------------|---|---|----------|--------------|
| Title :     |   | Horizontal Joint Installation - Stone Sill - Vertical Section |          |              |
| Drawing No. | HAZCD-HA01-ST-09  |   |          |              |
| Series      | Concept Drawings - Natural Stone Fixing System - HA01-554 Support Anchors |   |          |              |
| Revision    | 01  | scale   | As Shown | Page : 09/11 |

# HA01

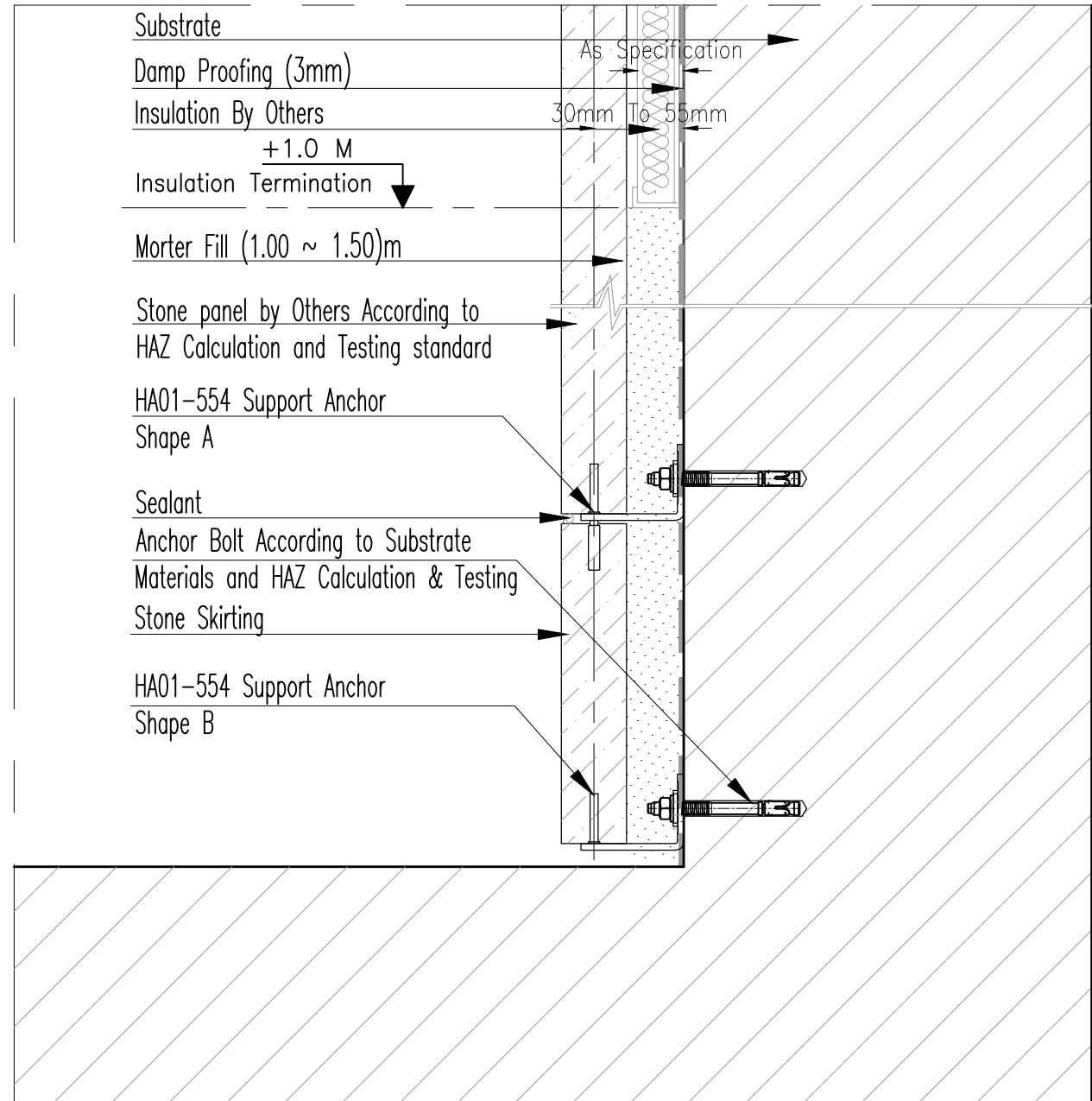

Vertical section Scale 1:4

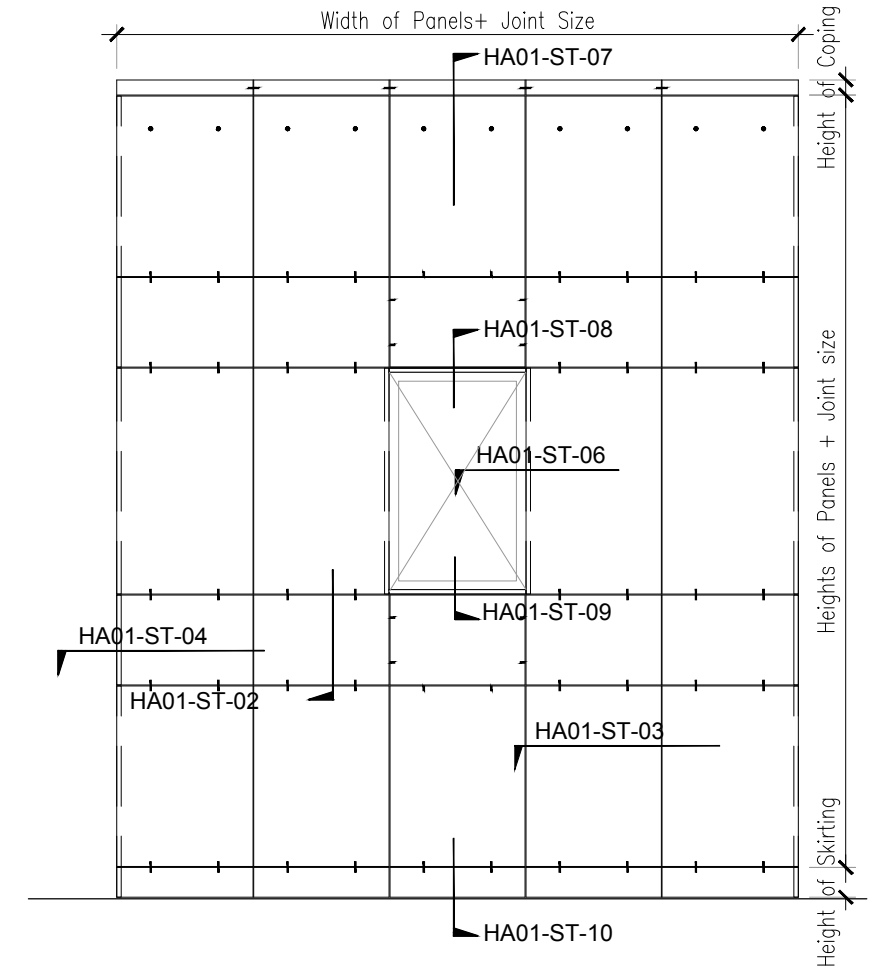

Elevation Scale 1:50



HAZ METAL Sanayi ve Ticaret A.S  
 PO Box 241 31200 Iskenderun / Turkey  
 Tel: +90 326 6262050 Faks: 6262045  
 info@hazmetal.com / www.hazmetal.com.

|             |   |   |          |              |
|-------------|---|---|----------|--------------|
| Title :     |   | Horizontal Joint Installation - Stone Skirting - Vertical Section |          |              |
| Drawing No. | HAZCD-HA01-ST-10  |   |          |              |
| Series      | Concept Drawings - Natural Stone Fixing System - HA01-554 Support Anchors |   |          |              |
| Revision    | 01  | scale   | As Shown | Page : 10/11 |

# HA01

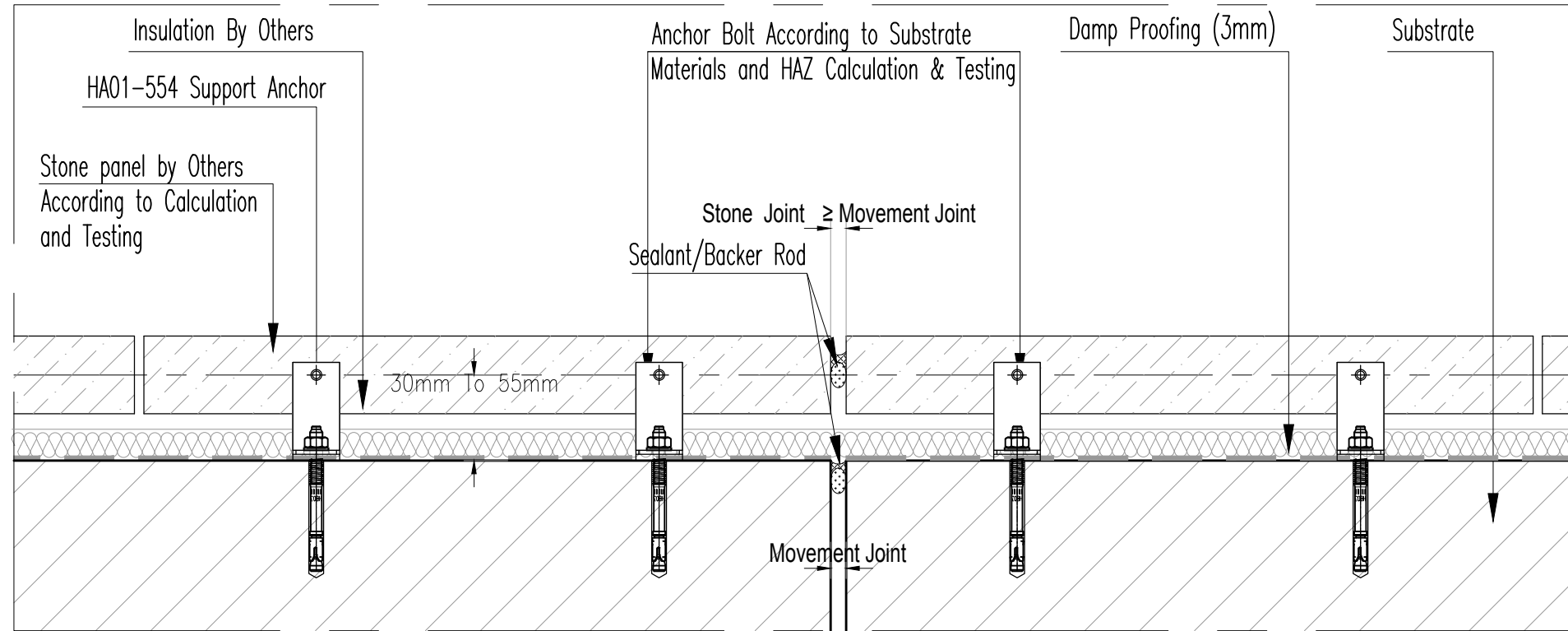

Horizontal section Scale 1:4

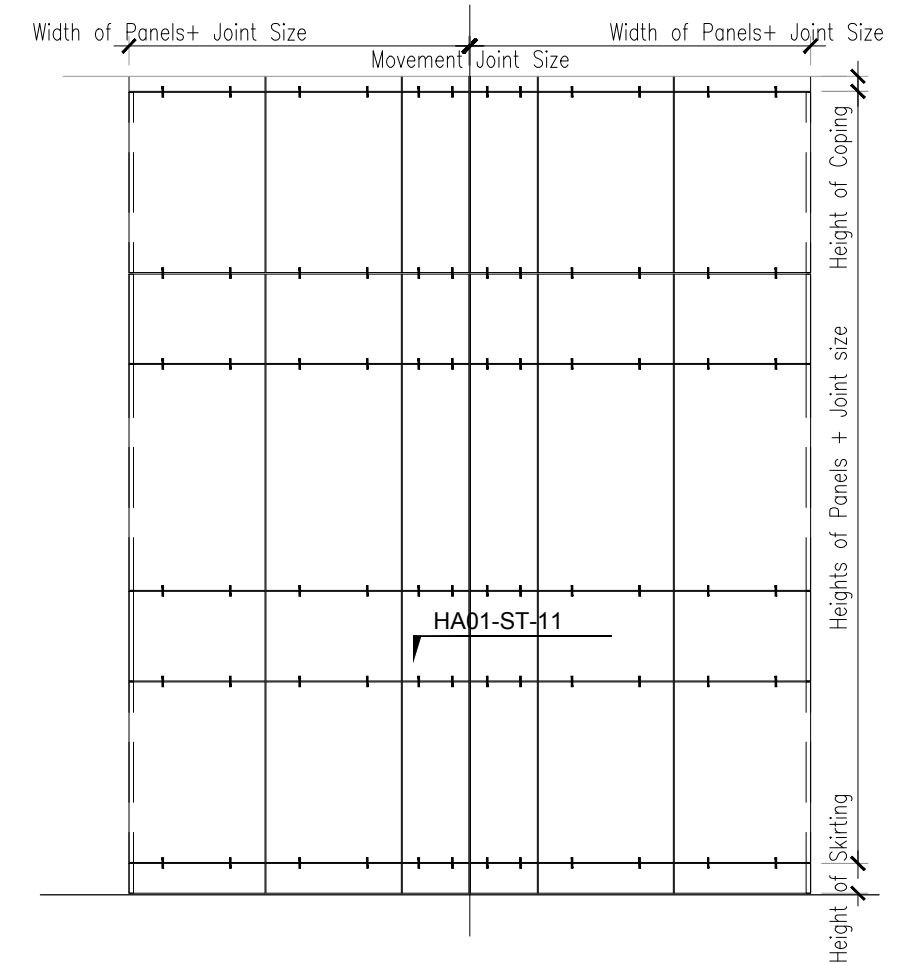

Variation on Typical Elevation  
Scale 1:50



HAZ METAL Sanayi ve Ticaret A.S  
PO Box 241 31200 Iskenderun / Turkey  
Tel: +90 326 6262050 Faks: 6262045  
info@hazmetal.com / www.hazmetal.com.

|   |   |       |          |              |
|---|---|-------|----------|--------------|
| Title : Horizontal Joint Installation - Typical Stone Claddings - Movement Joint - Horizontal Section |   |       |          |              |
| Drawing No.   | HAZCD-HA01-ST-11  |       |          |              |
| Series  | Concept Drawings - Natural Stone Fixing System - HA01-554 Support Anchors |       |          |              |
| Revision  | 01  | scale | As Shown | Page : 11/11 |